

SRX WORLD Software Synthesizer Owner's Manual



Introduction

For details on the settings for the DAW software that you're using, refer to the DAW's help or manuals.

About Trademarks

- VST is a trademark and software of Steinberg Media Technologies GmbH.
- Roland is a registered trademark or trademark of Roland Corporation in the United States and/or other countries.
- Company names and product names appearing in this document are registered trademarks or trademarks of their respective owners.



Contents

Introduction	2	EFFECTS Parameters	34
Screen Structure	4	Applying Effects	34
Using SRX WORLD	5	Effect Settings.....	34
How to Edit Values	5	Signal Flow and Parameters (ROUTING).....	34
Initializing a value.....	5	Multi-Effect Settings (MFX)	35
About the KEYBOARD button.....	5	Chorus and Reverb Settings.....	36
Overview of the SRX WORLD	6	Effects List	37
How the SRX WORLD is Organized	6	Multi-Effects Parameters (MFX)	37
How a Patch is Structured	6	About RATE and DELAY TIME	38
How a Rhythm Set is Structured	6	When Using 3D Effects	38
Calculating the Number of Voices Being Used	6	About the STEP RESET function.....	38
About the Effects	7	Chorus Parameters.....	69
About the Effects	7	Reverb Parameters	69
Memory and Bank	8		
What is a Memory?.....	8		
Bank	8		
Changing to Other Bank.....	8		
Exporting the Bank	8		
Importing a Bank	8		
Creating/Deleting a Bank.....	8		
Renaming a Bank	8		
Category.....	9		
Memory	9		
Loading a Memory.....	9		
Saving the Memory	9		
Renaming the Memory.....	9		
Changing the Order of the Memories	9		
Settings	10		
Option	10		
Detailed Editing for a Patch (PATCH Parameters)	11		
How to Edit a Patch	11		
Copying/Pasting Patch Parameters	11		
TONE SWITCH/SELECT.....	11		
Stereo Wave Settings (Set Stereo Function)	12		
PATCH Parameters	13		
COMMON	13		
STRUCTURE.....	15		
WG + PITCH.....	17		
TVF	19		
TVA.....	21		
LFO.....	23		
VELOCITY & KEY RANGE	25		
MATRIX CONTROL	26		
CONTROL SW	26		
Detailed Editing for a Rhythm Set (RHYTHM Parameters) ..	28		
How to Edit a Rhythm Set	28		
Copying/Pasting Rhythm Parameters	28		
WG	28		
Stereo Wave Settings (Set Stereo Function)	28		
RHYTHM Parameters	29		
COMMON	29		
WG	29		
PITCH + TVF.....	30		
TVA + VELOCITY	32		

Screen Structure

Main window

Here you can select sounds, turn effects on/off, and access windows.

[NAME] button

Renames a memory.

Patch Memory name

This area shows the name of the selected memory.

[MASTER LEVEL] knob

Adjusts the overall volume.

[▲] [▼] buttons

Select the next or previous memory.

[EDIT] button

Accesses the edit screen.

[UTILITY] button

Allows you to copy or paste groups of parameters (such as tone or MFX).

[KEYBOARD] button

Shows/hides the keyboard window.

[OPTION] button

Allows you to make various settings and authorizations.

[HELP] button

Displays help.

[MESSAGE] indicator

Lights when performance data is received.

[ABOUT] button

Here you can view information about the SRX WORLD.

Level meter

Displays output levels of the SRX WORLD.



LIST

Displays a list of sounds. You can select a sound from the list.

[BANK] button

Displays a list organized by bank.

[CATEGORY] button

Displays a list organized by category.

[PORTAMENTO] button

Turns portamento on/off.

[LEGATO] button

This setting specifies whether the Legato Switch will be used (ON) or not (OFF).

With the LEGATO SW "ON," pressing a key while continuing to press a previous key causes the note to change pitch to the pitch of the most recently pressed key, sounding all the while.

[MONO/POLY] button

When the button is lit, the instrument plays monophonically (mono).
When the button is unlit, the instrument plays polyphonically (poly).

TONE SWITCH

[1] [2] [3] [4] buttons

Select the tone(s) that will be heard.

EFFECTS

Press these buttons to turn on/off the MFX, chorus, or reverb effects.

[REVERB] button

Turns reverb on/off.

[CHORUS] button

Turns chorus on/off.

[MFX] button

Turns multi-effect on/off.

Using SRX WORLD



- In the navigation window, you can click various buttons to choose the parameters that are shown in the parameter window.
- The parameter window shows an editing screen for the parameters that you chose in the navigation window.
- The edit window includes both the parameter window and the navigation window.

How to Edit Values

You can edit values by clicking (and dragging) the buttons, sliders, or knobs.

- If you feel that the sliders and knobs in the panel are too small, and find it difficult to make detailed settings, try clicking (and holding) a knob or slider and then dragging the mouse farther away. This lets you set the value at any position as long as you continue holding down the mouse button. When doing so, you will be able to make precise adjustments to the value whenever the mouse cursor is away from the center of the knob or slider.
- When a value is shown, you can use the cursor keys (up/down/left/right) or mouse wheel to edit the value.

Initializing a value

Windows 7/8.1/10 Users

You can initialize the value of a parameter by holding down the Ctrl key of the computer and clicking the slider or knob of that parameter.

Macintosh Users

You can initialize the value of a parameter by holding down the command key of the computer and clicking the slider or knob of that parameter.

About the KEYBOARD button

When you click the **[KEYBOARD]** button located in the top line of the main window, the Keyboard window will appear, allowing you to transmit note messages by clicking the mouse.

If you drag the Velocity slider located at the left edge of the keyboard window all the way down, the value changes to **"VARIABLE."** With this setting, the velocity changes according to the position of the keyboard that you click.

Clicking the top edge of the keyboard produces minimum velocity, and clicking the bottom edge produces maximum velocity.

Overview of the SRX WORLD

How the SRX WORLD is Organized

How a Patch is Structured

Patches are the basic sound configurations that you play during a performance. Each patch can be configured by combining up to four tones.

Each tone can be turned on/off individually, allowing you to select the tones that will produce sound.

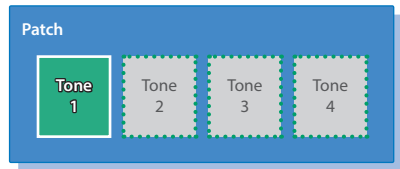

Example 1: A Patch consisting of only one Tone (Tones 2-4 are turned off).



Example 2: A Patch consisting of four Tones.

Tone

On the SRX WORLD, the tones are the smallest unit of sound. However, it is not possible to play a tone by itself. The patch is the unit of sound which can be played, and the tones are the basic building blocks which make up the patch.

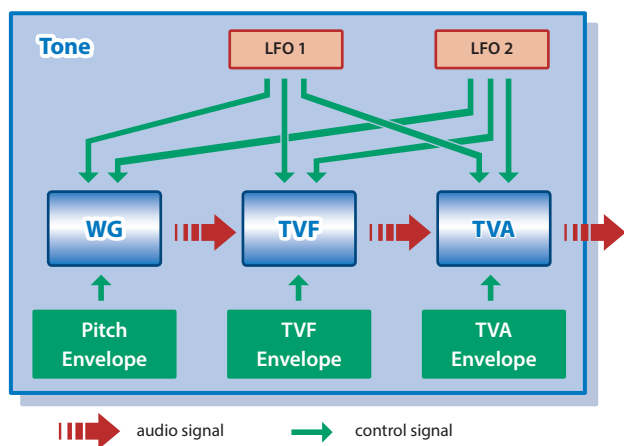

WG (Wave Generator)

Specifies the PCM waveform (wave) that is the basis of the sound, and determines how the pitch of the sound will change.

TVF (Time Variant Filter)

Specifies how the frequency components of the sound will change.

TVA (Time Variant Amplifier)

Specifies the volume changes and the sound's position in a stereo soundfield.

Envelope

You use Envelope to initiate changes to occur to a sound over time. There are separate envelopes for Pitch, TVF (filter), and TVA (volume).

LFO (Low Frequency Oscillator)

Use the LFO to create cyclic changes (modulation) in a sound. The SRX WORLD has two LFOs. Either one or both can be applied to effect the WG (pitch), TVF (filter) and/or TVA (volume). When an LFO is applied to the WG pitch, a vibrato effect is produced. When an LFO is applied to the TVF cutoff frequency, a wah effect is produced. When an LFO is applied to the TVA volume, a tremolo effect is produced.

How a Rhythm Set is Structured

Rhythm sets are groups of a number of different percussion instrument sounds.

Since percussion instruments generally do not play melodies, there is no need for a percussion instrument sound to be able to play a scale on the keyboard. It is, however, more important that as many percussion instruments as possible be available to you at the same time.

Therefore, each key (note number) of a rhythm set will produce a different percussion instrument.

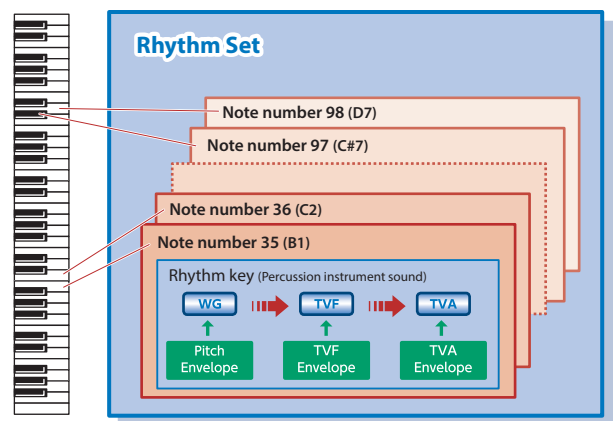

- * There are four wave generators for each rhythm key (percussion instrument sounds).
- * LFO is not included in the rhythm keys (percussion instrument sounds).

Calculating the Number of Voices Being Used

The SRX WORLD is able to play up to 128 notes simultaneously.

The polyphony, or the number of voices (sounds) does not refer only to the number of patches actually being played, but changes according to the number of tones used in the patches, and the number of waves used in the tones. The following method is used to calculate the number of sounds used for one patch being played.

(Number of patches being played) x (Number of tones used by patches being played) x (Number of waves used in the tones)

For example, a patch that combines four tones, each of which use two waves, will use eight notes of polyphony at once. Also, when playing in Performance mode, the number of sounds for each part is counted to obtain the total number of sounds for all parts.

How a Patch Sounds

When the SRX WORLD is requested to play more than 128 voices simultaneously, currently sounding notes will be turned off to make room for newly requested notes. The note with the lowest priority will be turned off first. The order of priority is determined by the Patch Priority setting (PRIORITY; p. 13).

Patch Priority can be set either to **"LAST"** or **"LOUDEST:"**

When **"LAST"** is selected, a newly requested note that exceeds the 128 voice limit will cause the first-played of the currently sounding notes to be turned off.

When **"LOUDEST"** is selected, the quietest of the currently sounding notes will be turned off. Usually, **"LAST"** is selected.

About the Effects

The SRX WORLD has built-in effect units, and you can independently edit each unit's settings.

Multi-Effects

The multi-effects are multi-purpose effects that completely change the sound type by changing the sound itself.

Contained are 78 different effects types; select and use the type that suits your aims.

In addition to effects types composed of simple effects such as Distortion, Flanger, and other such effects, you can also set up a wide variety of other effects, even connecting effects in series or in parallel. Furthermore, while chorus and reverb can be found among the multi-effect types, the following chorus and reverb are handled with a different system.

Chorus

Chorus adds depth and spaciousness to the sound.

You can select whether to use this as a chorus effect or a delay effect.

Reverb

Reverb adds the reverberation characteristics of halls or auditoriums.

Five different types are offered, so you can select and use the type that suits your purpose.

How effects are handled

The multi-effects, chorus and reverb effects can be set up individually for each patch/rhythm set.

Adjusting the signal level to be sent to each effects unit (Send Level) provides control over the effect intensity that's applied to each tone.

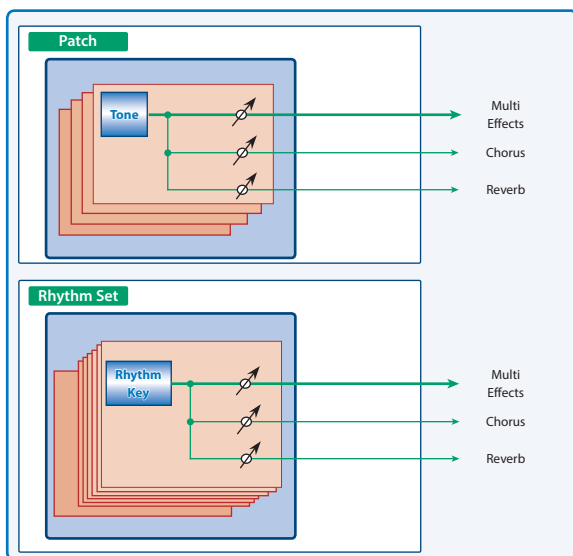

Memory and Bank

What is a Memory?

Each of the SRX WORLD's sounds is called a "memory." A memory can be either a "patch" or a "rhythm set."

Bank

1. Click the [BANK] button.

The Memory Select screen (BANK) appears.

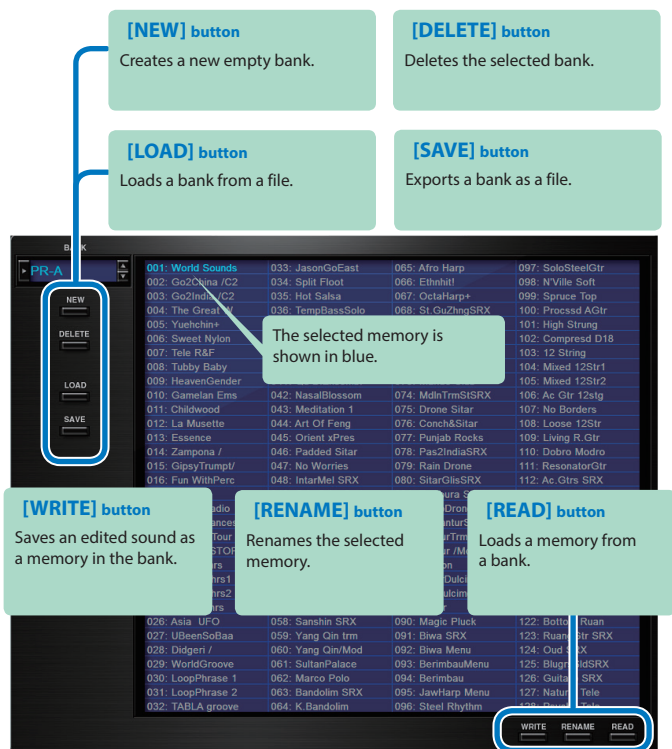

A set of 128 memories is called a "bank." By switching banks you can access a large number of memories. A bank of memories can be saved as a file.

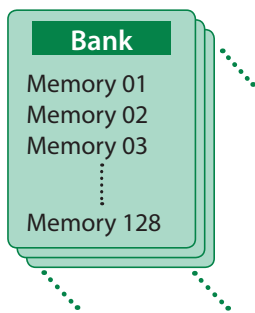

Rhythm Sets have a small symbol at their upper left.

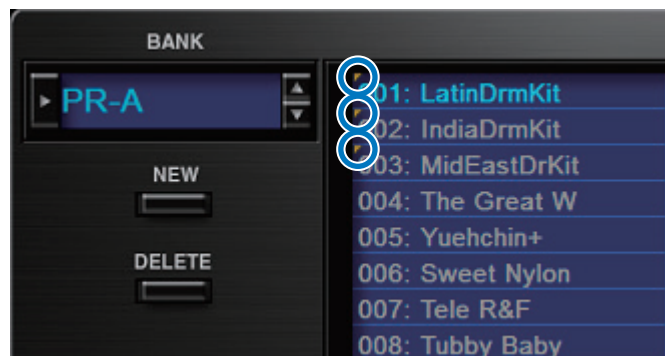

Changing to Other Bank

1. Click the Bank field.

The bank list window opens.

2. Click the bank that you want to recall.

By pressing the [▲] [▼] buttons located at the right of the bank field, you can switch to the next or previous bank.

Exporting the Bank

Here's how to export a bank as a file.

1. Click the [SAVE] button.

The file name input window opens.

2. Enter a file name and save.

The file is exported.

Importing a Bank

1. Click the [LOAD] button.

The file selection window opens.

2. Select a file and load it.

The bank is loaded.

Creating/Deleting a Bank

Creating a bank

Click the [NEW] button to create a new empty bank.

Deleting a bank

Here's how to delete the selected bank.

1. Select a bank as described in "Changing to Other Bank" (p. 8).

2. Click the [DELETE] button.

A confirmation screen appears.

3. Click [OK] to delete the bank.

Renaming a Bank

1. Select a bank as described in "Changing to Other Bank" (p. 8).

2. Click ► located at the left of the bank field.

3. Edit the name and press the [Return (Enter)] key.

Category

1. Click the [CATEGORY] button.

Memory Select screen (CATEGORY) appears.



Keyboard shortcuts

Keyboard shortcuts for the Patch Select window.

Key	Function
Command (Ctrl) + B	Changes bank
Command (Ctrl) + I	Imports bank
Command (Ctrl) + E	Exports bank
Command (Ctrl) + N	New memory
Command (Ctrl) + O	Loads memory
Command (Ctrl) + S	Saves memory
Up/Down/Left/Right	Selects memory
Space	Renames memory
Command (Ctrl) + C	Copies memory
Command (Ctrl) + V	Pastes memory
Delete *1 delete  *2	Deletes memory
fn + delete *2	Deletes memory
Return (Enter)	Loads memory
Command (Ctrl) + Z	Undo
Command (Ctrl) + Shift + Z	Redo
Command (Ctrl) + J	Switches the memory number indication <ul style="list-style-type: none"> • 001-128 • 01-1-01-8, 02-1-...-16-8 • A-1-A-8, B-1-...-P-8
Esc	Closes window

Memory

The SRX WORLD manages 128 memories as one bank.

Loading a Memory

Here's how to load a memory from a bank. When you load a memory, its settings appear in the edit area and can be edited.

1. Click the number of the memory that you want to load.
2. Click the [READ] button. Or press the [Return (Enter)] key.

The memory is loaded.

* You can also load a memory by double-clicking a memory number.

Saving the Memory

Here's how to save an edited sound as a memory in the bank.

1. Click the number of the memory in which you want to save the sound.
2. Click the [WRITE] button.

The memory is saved in the bank.

Renaming the Memory

1. Click the number of the memory that you want to rename.
2. Click the [RENAME] button.
3. Change the memory name. (Up to 16 letters)

Changing the Order of the Memories

Drag the memory number to change the order of memories.

*1 Windows / *2 Mac

Settings

Option

1. Click the [OPTION] button.



2. Select items.

A ✓ is shown for the selected item.

Item	Explanation
Zoom 75%	Changes the size of the main window.
Zoom 100%	
Zoom 125%	
Zoom 150%	
Zoom 175%	
Zoom 200%	
Flip Scroll Direction (Only on Mac)	Inverts the direction of rotation when using the mouse wheel to edit a value.
Roland Cloud...	Displays the Roland Cloud site.
Authentication...	Performs user authentication for the SRX WORLD.

Detailed Editing for a Patch (PATCH Parameters)

“Editing” is the process of modifying the values of the SRX WORLD’s various settings (parameters). This chapter explains the procedure for patch editing, and how the patch parameters work.



TONE SWITCH/SELECT

Use TONE SWITCH (SW) 1–4 to turn each of the four tones on/off.

Use TONE SELECT 1–4 to select the tone that you want to edit.

[LFO] editing screen



How to Edit a Patch

You can create a new patch by editing an existing patch.

A patch consists of up to four “tones.” Before editing a patch, you should listen to each tone individually to familiarize yourself with the role it plays in creating the overall sound of the patch.

Copying/Pasting Patch Parameters

You can select and copy a portion of the patch parameters (such as a patch tone or MFX), and then paste those parameters to another patch tone or another patch. You can also initialize the settings of a patch or rhythm set.

1. In the main window, click the [UTILITY] button.

A popup appears.

Item	Explanation
Initialize	Initializes the settings of the patch or rhythm set. This is convenient when you want to create data from scratch.
Copy	Copies the selected parameters from the currently selected patch or rhythm set to the clipboard.
Paste	Pastes the selected parameter from the clipboard to the current patch or rhythm set.

2. Select “Initialize”, “Copy” or “Paste.”

A list of the items that can be initialized or copied, or a list of the destinations to which data can be written, appears.

3. In the list, click to select the desired item.

- The parameter window will show the settings of the first selected of the currently selected tones (the button is lit red.).
- You can select multiple tones by clicking a TONE SELECT button while holding down the computer’s Shift key.
- You can select all tones by clicking a TONE SELECT button while holding down the computer’s Command (Ctrl) key.
- When you edit the settings of a tone, the settings of the currently selected tones will change simultaneously.

Four tips when creating patches

- Choose a patch that’s close to what you have in mind
If you’re trying to create a new patch, it will be difficult to make progress if you simply select any old patch and start making changes blindly. It’s important to start by selecting a patch that’s close to what you have in mind.
- Decide which tones you’ll use
When creating a patch, it’s very important to decide which tones you’re going to use. In the edit screen, use the TONE SWITCH 1–4 settings to specify whether each tone will be heard (on) or silent (off). Turning off unneeded tones is also an important way to conserve polyphony.
- Check the structure setting (p. 15)
The STRUCTURE parameter is a very important one; it specifies how the four tones will be combined. Before you begin actually editing the tones, you must understand the relationship between the tones.
- Turn the effects off (p. 34)
The SRX WORLD contains a diverse array of effects, allowing you to process the sound in sophisticated ways. Effects have a major impact on the sound, and simply turning off the effects may produce an entirely different impression. Turning off the effects will allow you to hear the sound of the patch itself, which makes it easier to hear the result of the changes you make. In some cases, editing the effect settings may be enough to create the sound you want.

[WG+PITCH], [TVF], [TVA], [CONTROL SW] editing screens



- You can select multiple tones by clicking a TONE SELECT button while holding down the computer's Shift key.
- When you edit the settings of a tone, the settings of the currently selected tones will change simultaneously.
- Unselected tones can be edited independently.

Stereo Wave Settings (Set Stereo Function)

Some of the waves that make up a tone key are stereo.

With stereo waves, the name of a left-channel wave ends in "L," while the name of a right-channel wave ends in "R."

The left and right waves are numbered consecutively; the right-channel wave number is one greater than the left-channel wave number.

You can use the following procedure to first select either the left or right wave, and then select the other wave.

1. Select a patch.
2. Make sure that "WG+PITCH" is selected in the "PATCH" area of the navigation window.
3. Use WAVE NUMBER L to select the left-channel wave of the stereo wave.
4. While holding down the Command (Ctrl) key, click on WAVE NUMBER R.

The corresponding right-channel wave will be selected.

MEMO

After selecting the right-channel wave in WAVE NUMBER R, you can also hold down the Command (Ctrl) key and click on WAVE NUMBER L to select the left-channel wave.

If the wave is not a stereo wave, the selection won't change.

Note when selecting a waveform

The SRX WORLD uses complex PCM waveforms as the basis for its sounds. For this reason, you should be aware that if you specify a waveform that is very different than the original waveform, the result may not be what you expect.

The SRX WORLD's internal waveforms can be categorized into the following two types.

One-shot:

These are sounds with a short decay time. One-shot waveforms contain the entire duration of the sound from the attack until it decays to silence. Some of these waveforms capture a complete sound such as a percussion instrument, but there are also many attack component sounds such as the hammer strike of a piano or the fret noise of a guitar.

Loop:

These are sounds with a long decay, or sustaining sounds.

Looped waveforms will repeatedly play a portion of a sound once it has reached a relatively stable state. These sounds also include numerous component sounds, such as a vibrating piano string or a resonating pipe.

The following illustration shows an example of a sound created by combining a one-shot waveform with a loop waveform. (This example is of an electric organ.)

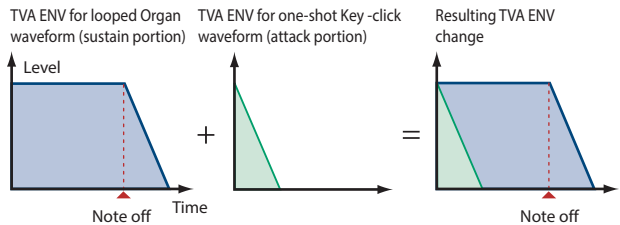

Note when selecting a one-shot waveform

It's not possible to use the envelope settings to give a one-shot waveform a longer decay than the original waveform contains, or to make it a sustaining sound. Even if you made this type of envelope setting, you would be trying to bring out something that doesn't exist in the original waveform.

Note when selecting a looped waveform

Many acoustic instruments such as piano or sax are marked by a sudden change in timbre at the very beginning of the sound, and this rapid change is what gives the instrument its distinctive character. When using these waveforms, it's best to use the complex tonal changes in the attack portion of the sound without attempting to modify them; use the envelope only to modify the decay portion of the sound as desired. If you use the envelope to modify the attack as well, the envelope settings will be affected by the attack of the waveform itself, and you may not get the result you intend.

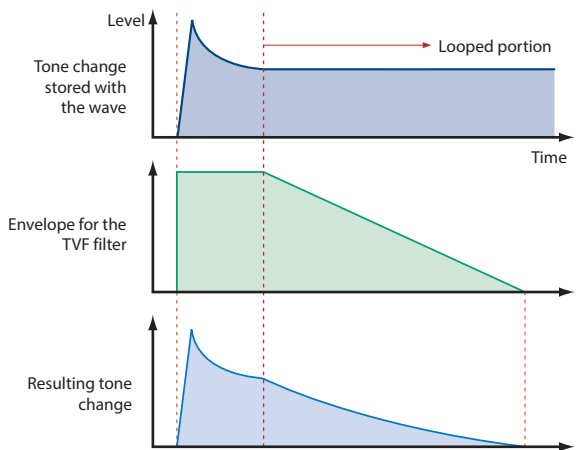

PATCH Parameters

COMMON

PATCH COMMON



Parameter	Range/Explanation
PATCH NAME	Patch name
CATEGORY	Type (category) of the patch
LEVEL	0–127 Volume before passing through MFX/Reverb/Chorus For distortion-type effects, the tonal character changes depending on the volume that is input. As appropriate for your purpose, adjust this in conjunction with the [MASTER LEVEL] knob.
PAN	L64–0–63R Left/right position of the patch
OUTPUT ASSIGN	Specifies how the direct sound of each patch will be output. MFX: Output in stereo through multi-effects. You can also apply chorus or reverb to the sound that passes through multi-effects. L+R: Output in stereo to the OUTPUT without passing through the multi-effect L: Output in mono to the OUTPUT L without passing through the multi-effect R: Output in mono to the OUTPUT R without passing through the multi-effect tone: Outputs according to the settings for each tone.
OCTAVE SHIFT	-3–3 Pitch of the patch's sound (in units of an octave)
TUNE	COARSE -48–48 Pitch of the patch's sound (in semitones, +/- 4 octaves)
	FINE -50–50 Pitch of the patch's sound (in 1-cent steps; one cent is 1/100th of a semitone)
STRETCH TUNE DEPTH	Stretched tuning (a system by which acoustic pianos are normally tuned, causing the lower range to be lower and the higher range to be higher than the mathematical tuning ratios would otherwise dictate) OFF: Equal temperament 1–3: Higher settings will produce the greater difference in the pitch of the low and high ranges.

Parameter	Range/Explanation
-----------	-------------------

Stretched Tuning

Pitch difference from equal temperament

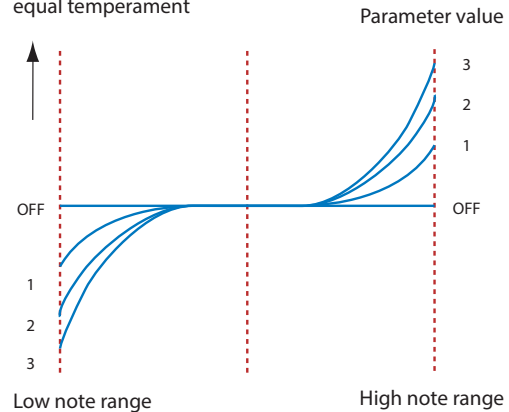

PITCH BEND RANGE	UP	0–48 Amount of pitch change (in semitones) that occurs when the pitch bend controller is at the maximum position
	DOWN	-48–0 Amount of pitch change (in semitones) that occurs when the pitch bend controller is at the minimum position
MASTER TUNE		415.3–466.2 Hz Overall tuning of the SRX WORLD The display shows the frequency of the A4 note (center A).
MASTER KEY SHIFT		-24–+24 Shifts the overall pitch of the SRX WORLD in semitone steps.
OFFSET	CUTOFF	-63–+63 CUTOFF (p. 19)
	RES	-63–+63 RES (p. 19)
	ATTACK TIME	-63–+63 TVF Envelope Time 1, TVA Envelope Time 1 (p. 20, p. 22)
	RELEASE TIME	-63–+63 TVF Envelope Time 4, TVA Envelope Time 4 (p. 20, p. 22)
VELOCITY SENS		-63–+63 Cutoff Velocity Sens, TVA Velocity Sens (p. 20, p. 21)
		How notes will be managed when the maximum polyphony is exceeded (128 voices) LAST: The last-played voices will be given priority (Notes will be turned off in order, beginning with the first-played note.) LOUDEST: The loudest voices will be given priority (Notes will be turned off, beginning with the lowest-volume voice.)
MONO/POLY		MONO: Only the last-played note will sound. This setting is effective when playing a solo instrument patch such as sax or flute. POLY: Two or more notes can be played simultaneously.

Parameter	Range/Explanation
LEGATO (*1)	<p>SW</p> <p>This setting specifies whether the Legato Switch will be used (ON) or not (OFF). LEGATO SW is valid when the Mono/Poly parameter is set to "MONO"</p> <p>With the LEGATO SW "ON," pressing a key while continuing to press a previous key causes the note to change pitch to the pitch of the most recently pressed key, sounding all the while.</p> <p>This creates a smooth transition between notes, which is effective when you wish to simulate the hammering-on and pulling-off techniques used by a guitarist.</p>
	<p>RETRIGGER</p> <p>The setting determines whether sounds are replayed (ON) or not (OFF) when performing legato. Normally you will leave this parameter "ON."</p> <p>The LEGATO RETRIGGER is valid when the Mono/Poly is set to "MONO" and the LEGATO SW is set to "ON."</p> <p>When "OFF," when one key is held down and another key is then pressed, only the pitch changes, without the attack of the latter key being played.</p> <p>Set this to "OFF" when performing wind and string phrases or when using modulation with the mono synth keyboard sound.</p>
ANALOG FEEL	<p>0-127</p> <p>Depth of 1/f modulation (a pleasant and naturally-occurring ratio of modulation that occurs in a babbling brook or rustling wind)</p> <p>* You can simulate the natural instability characteristic of an analog synthesizer by adding this "1/f modulation."</p>
PORTAMENTO	<p>SW</p> <p>Specifies whether the portamento effect will be applied (ON) or not (OFF).</p> <p>Portamento is an effect which smoothly changes the pitch from the first-played key to the next-played key.</p>
	<p>MODE</p> <p>NORMAL: Portamento will always be applied. LEGATO: Portamento will be applied only when you play legato.</p>
	<p>TYPE</p> <p>RATE: Speed of pitch change is uniform (the time required for the pitch change will correspond to the distance of the pitch change) TIME: The time it takes will be constant, regardless of how far apart in pitch the notes are.</p>
	<p>START</p> <p>PITCH: Start a new portamento from present pitch when another key is pressed while the pitch is changing. NOTE: Portamento will begin anew from the pitch where the current change would end.</p>
	<p>TIME</p> <p>0-127</p> <p>Specifies the time over which the pitch will change.</p>

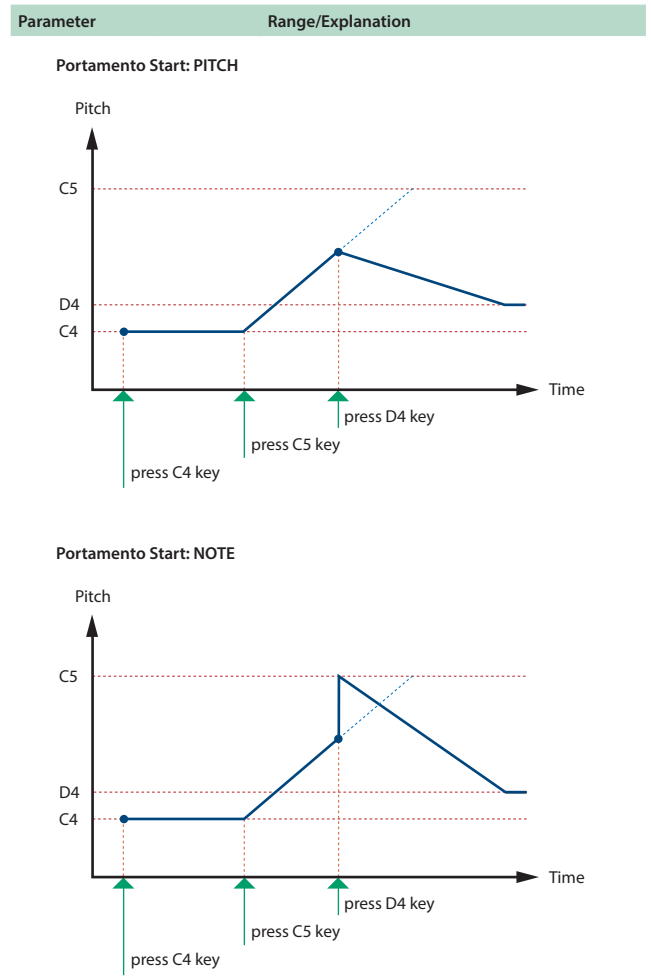

*1 Let's say you have the LEGATO SW set to **"ON,"** and the LEGATO RETRIGGER set to **"OFF."** When you try to sound a legato (by pressing a higher key while a lower key is held down), the pitch may sometimes not be able to rise all the way to the intended pitch (stopping instead at an intermediate pitch). This can occur because the limit of pitch rise, as determined on each wave form. Additionally, if differing upper pitch limits are used for the waves of a Patch that uses multiple tones, it may not being heard as MONO. When making large pitch changes, set the LEGATO RETRIGGER to **"ON."**

PATCH SCALE TUNE



The SRX WORLD allows you to play the keyboard using temperaments other than equal temperament. The pitch is specified in one-cent units relative to the equal tempered pitch. One-cent is 1/100th of a semitone.

Parameter	Range/Explanation
SCALE TUNE SWITCH	<p>OFF, ON</p> <p>Turn this on when you wish to use a tuning scale other than equal temperament.</p>

Parameter	Range/Explanation
C-B	-64--+63 Make scale tune settings for Patch mode.

Equal Temperament

This tuning divides the octave into 12 equal parts, and is the most widely used method of temperament used in Western music. The SRX WORLD employs equal temperament when the Scale Tune Switch is set to "OFF."

Just Intonation (Tonic of C)

Compared with equal temperament, the principle triads sound pure in this tuning. However, this effect is achieved only in one key, and the triads will become ambiguous if you transpose.

Arabian Scale

In this scale, E and B are a quarter note lower and C#, F# and G# are a quarter-note higher compared to equal temperament. The intervals between G and B, C and E, F and G#, Bb and C#, and Eb and F# have a neutral third-the interval between a major third and a minor third. On the SRX WORLD, you can use Arabian temperament in the three keys of G, C and F.

Note name	Equal temperament	Just intonation (tonic C)	Arabian scale
C	0	0	-6
C#	0	-8	+45
D	0	+4	-2
Eb	0	+16	-12
E	0	-14	-51
F	0	-2	-8
F#	0	-10	+43
G	0	+2	-4
G#	0	+14	+47
A	0	-16	0
Bb	0	+14	-10
B	0	-12	-49

STRUCTURE

PATCH STRUCTURE

Structure changes how a tone is sounded.

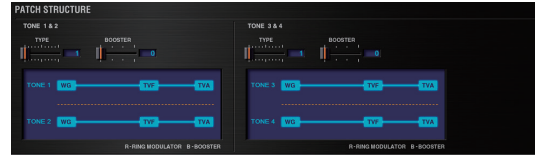

Parameter	Range/Explanation
TONE 1 & 2, 3 & 4 TYPE	1-10 Determines how tone 1 and 2, or tone 3 and 4 are connected. The following 10 different Types of combination are available.

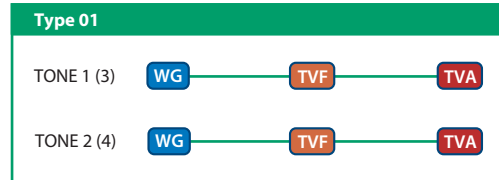

With this type, tones 1 and 2 (or 3 and 4) are independent. Use this type when you want to preserve PCM sounds or create and combine sounds for each tone.

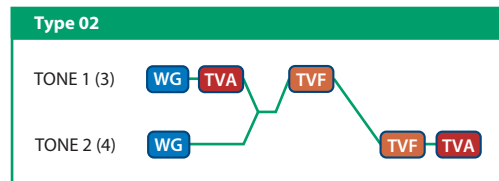

This type stacks the two filters together to intensify the characteristics of the filters. The TVA for tone 1 (or 3) controls the volume balance between the two tones.

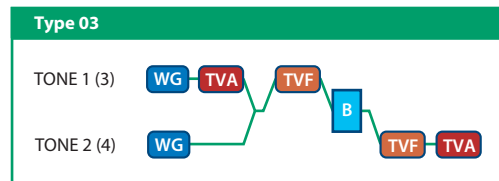

This type mixes the sound of tone 1 (3) and tone 2 (4), applies a filter, and then applies a booster to distort the waveform.

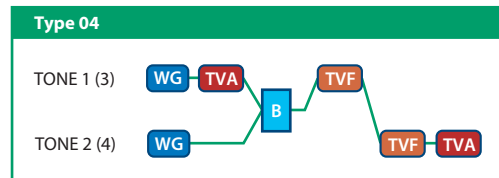

This type applies a booster to distort the waveform, and then combines the two filters. The TVA for tone 1 (or 3) controls the volume balance between the two tones and adjusts booster level.

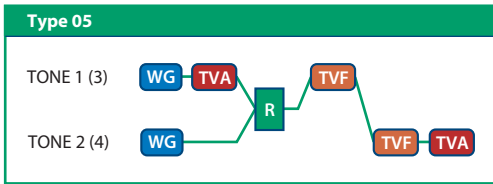

This type uses a ring modulator to create new overtones, and combines the two filters. The tone 1 (3) TVA will control the volume balance of the two tones, adjusting the depth of ring modulator.

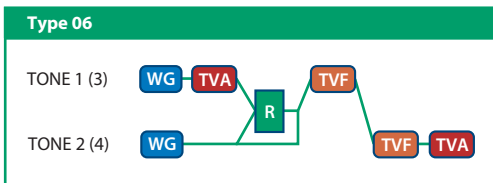

This type uses a ring modulator to create new overtones, and in addition mixes in the sound of tone 2 (4) and stacks the two filters. Since the ring-modulated sound can be mixed with tone 2 (4), tone 1 (3) TVA can adjust the amount of the ring-modulated sound.

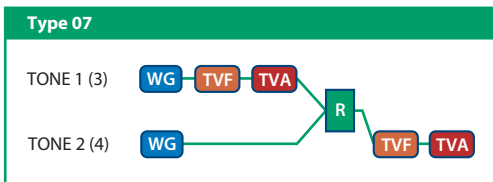

This type applies a filter to tone 1 (3) and ring-modulates it with tone 2 (4) to create new overtones.

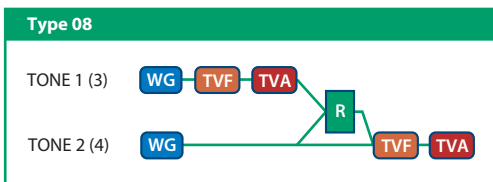

This type sends the filtered tone 1 (3) and tone 2 (4) through a ring modulator, and then mixes in the sound of tone 2 (4) and applies a filter to the result.

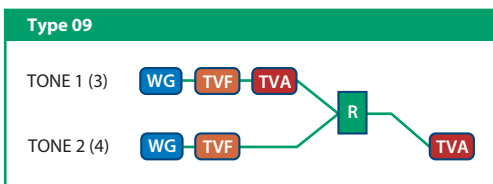

This type passes the filtered sound of each tone through a ring modulator to create new overtones. The tone 1 (3) TVA will control the volume balance of the two tones, adjusting the depth of ring modulator.

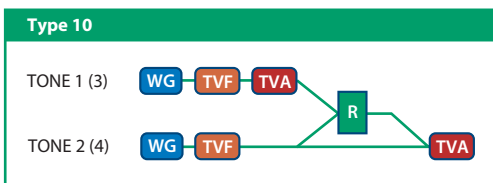

This type passes the filtered sound of each tone through a ring modulator to create new overtones, and also mixes in the sound of tone 2 (4). Since the ring-modulated sound can be mixed with tone 2 (4), tone 1 (3) TVA can adjust the amount of the ring-modulated sound.

- * When TYPE 02–10 is selected and one tone of a pair is turned off, the other tone will be sounded as TYPE 01 regardless of the displayed setting.
- * If you limit the keyboard area in which a tone will sound (KEY RANGE, p. 25) or limit the range of velocities for which it will sound (VELOCITY RANGE, p. 25), the result in areas or ranges where the tone does not sound is just as if the tone had been turned off. This means that if TYPE 02–10 is selected and you create a keyboard area or velocity range in which one tone of a pair does not sound, notes played in that area or range will be sounded by the other tone as TYPE 01 regardless of the displayed setting.

Parameter	Range/Explanation
TONE 1 & 2, 3 & 4 BOOSTER	0, +6, +12, +18 Specifies the amount of boost that is applied (when the Structure Type is 03 or 04) The booster distorts the sound by boosting the input signal, producing the distortion effect that is often used with an electric guitar. Increasing this value will produce stronger distortion.

Booster

The Booster is used to distort the incoming signal.

In addition to using this other than to create distortion, you can use the waveform (WG1) of one of the tones as an LFO which shifts the other waveform (WG2) upward or downward to create modulation similar to PWM (pulse width modulation). This parameter works best when you use it in conjunction with the WAVE GAIN parameter (p. 18).

Ring Modulator

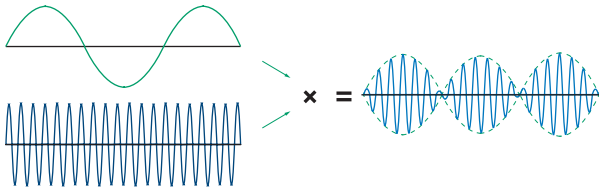

A ring modulator multiplies the waveforms of two tones with each other, generating many new overtones (inharmonic partials) which were not present in either waveform (Unless one of the waveforms is a sine wave, evenly-spaced frequency components will not usually be generated.).

As the pitch difference between the two waveforms changes the harmonic structure, the result will be an unpitched metallic sound. This function is suitable for creating metallic sounds such as bells.

WG + PITCH

PATCH WG

This modifies Waveforms/Pitch Envelope.



Parameter marked with a "★" can be controlled using specified MIDI messages (Matrix Control, p. 26).

Parameter	Range/Explanation
Wave Group	Selects the group for the waveform that is to be the basis of the tone. Standard: Basic wave group SRX: SRX wave group
WAVE NUMBER L (Mono) /R	Off, 1- Basic waveform for a tone When in monaural mode, only the left side (L) is specified. When in stereo, the right side (R) is also specified. "Set Stereo function" To select a left/right pair of waveforms, select the left (L) WAVE No., and then hold down the Command (Ctrl) key and click the right (R) WAVE No. to recall the right (R) WAVE.

Parameter	Range/Explanation
TONE DELAY MODE (*1)	Type of tone delay NORMAL: The tone begins to play after the time specified in the TONE DELAY TIME parameter has elapsed. HOLD: Although the tone begins to play after the time specified in the TONE DELAY TIME parameter has elapsed, if the key is released before the time specified in the TONE DELAY TIME parameter has elapsed, the tone is not played. KEY-OFF-NORMAL: Rather than being played while the key is pressed, the tone begins to play once the period of time specified in the TONE DELAY TIME parameter has elapsed after release of the key. This is effective in situations such as when simulating noises from guitars and other instruments. KEY-OFF-DECAY: Rather than being played while the key is pressed, the tone begins to play once the period of time specified in the TONE DELAY TIME parameter has elapsed after release of the key. Here, however, changes in the TVA Envelope begin while the key is pressed, which in many cases means that only the sound from the release portion of the envelope is heard. * If you have selected a waveform that is a decay-type sound (i.e., a sound that fades away naturally even if the key is not released), selecting "KEY-OFF-NORMAL" or "KEY-OFF-DECAY" may result in no sound being heard.
TONE DELAY TIME (*1)	0-127, Note Time from when the key is pressed (or if the Tone Delay Mode parameter is set to "KEY-OFF-NORMAL" or "KEY-OFF-DECAY" the time from when the key is released) until when the tone will sound Specify this as a note value if you want to synchronize the delay to the tempo of the SRX WORLD.

*1 This produces a time delay between the moment a key is pressed (or released), and the moment the tone actually begins to sound. You can also make settings that shift the timing at which each tone is sounded. This differs from the Delay in the internal effects, in that by changing the sound character of the delayed tones and changing the pitch for each tone, you can also perform arpeggio-like passages just by pressing one key.

You can also synchronize the tone delay time to the tempo of the SRX WORLD.

- If you are not going to use Tone Delay, set the TONE DELAY MODE parameter to **"NORMAL"** and DELAY TIME parameter to **"0."**
- If STRUCTURE (p. 15) is set to TYPE 02-10, the settings for tone 1 (3) will follow the settings of tone 2 (4). (This is because the outputs of tones 1 and 2 are combined into tone 2, and the outputs of tones 3 and 4 are combined into tone 4.)

* The following illustration shows the operation of **"TVA Env."**

Tone Delay Mode: NORMAL

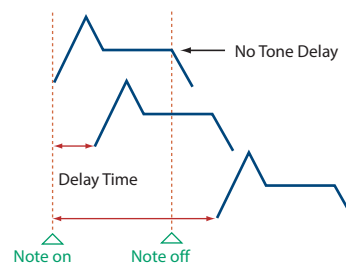

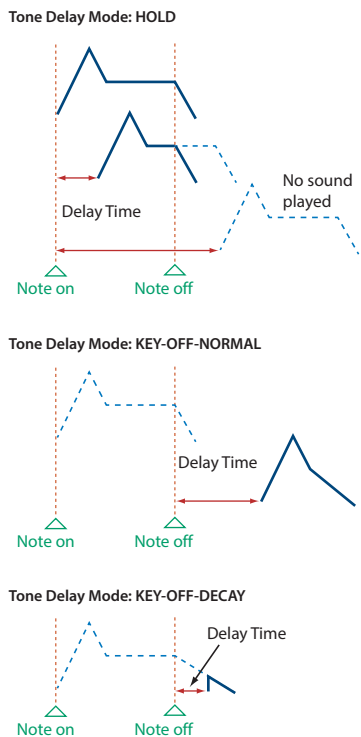

Parameter	Range/Explanation	
GAIN	-6, 0, +6, +12 Gain (amplification) of the waveform The value changes in 6 dB (decibel) steps—an increase of 6 dB doubles the waveform's gain. * If you intend to use the Booster to distort the waveform's sound, set this parameter to its maximum value (p. 16).	
TEMPO SYNC	Turn this "ON" if you want the Phrase Loop to match the tempo of the DAW. * When this parameter is set to "ON," set the TONE DELAY TIME parameter (p. 17) to "0."	
FXM (*2)	ON	This sets whether FXM will be used (ON) or not (OFF).
	COLOR	1-4 How FXM will perform frequency modulation Higher settings result in a grainier sound, while lower settings result in a more metallic sound.
	DEPTH ★	0-16 Depth of the modulation produced by FXM
TUNE	COARSE ★	-48-+48 Pitch of the tone's sound (in semitones, +/-4 octaves)
	FINE ★	-50-+50 Pitch of the tone's sound (in 1-cent steps; one cent is 1/100th of a semitone)
RANDOM PITCH	0-1200 Width of random pitch deviation that will occur each time a key is pressed (in 1-cent steps) If you do not want the pitch to change randomly, set this to "0."	
PITCH KF (Pitch Keyfollow)	-200-+200 Amount of pitch change that will occur when you play a key one octave higher If you want the pitch to rise one octave as on a conventional keyboard, set this to "+100." If you want the pitch to rise two octaves, set this to "+200."	

*2 FXM (Frequency Cross Modulation) uses a specified waveform to apply frequency modulation to the currently selected waveform, creating complex overtones. This is useful for creating dramatic sounds or sound effects.

PITCH ENV (WAVE PITCH ENVELOPE)

Parameter marked with a "★" can be controlled using specified MIDI messages. (Matrix Control, p. 26).

Parameter	Range/Explanation
DEPTH	-12-+12 Depth of the Pitch envelope Higher settings will cause the pitch envelope to produce greater change. Negative (-) settings will invert the shape of the envelope.
TIME KF (Time Keyfollow)	-100-+100 Use this setting if you want the pitch envelope times (T2-T4) to be affected by the keyboard location. Based on the pitch envelope times for the C4 key, positive (+) settings will cause notes higher than C4 to have increasingly shorter times.
VEL SENS (Velocity Sens)	-63-+63 Keyboard playing dynamics can be used to control the depth of the pitch envelope. If you want the pitch envelope to have more effect for strongly played notes, set this parameter to a positive (+) value.
T1 SENS (T1 Velocity Sens)	-63-+63 This allows keyboard dynamics to affect the T1 of the Pitch envelope. If you want T1 to be speeded up for strongly played notes, set this parameter to a positive (+) value.
T4 SENS (T4 Velocity Sens)	-63-+63 Use this parameter when you want key release speed to affect the T4 value of the Pitch envelope. If you want T4 to be speeded up for quickly released notes, set this parameter to a positive (+) value.
T1-4 ★ (Time 1-4)	0-127 Pitch envelope times (T1-T4) Higher settings will result in a longer time until the next pitch is reached.
L0-4 (Level 0-4)	-63-+63 Pitch envelope levels (L0-L4) Specify how the pitch will change at each point, relative to the pitch set with COARSE TUNE or FINE TUNE.

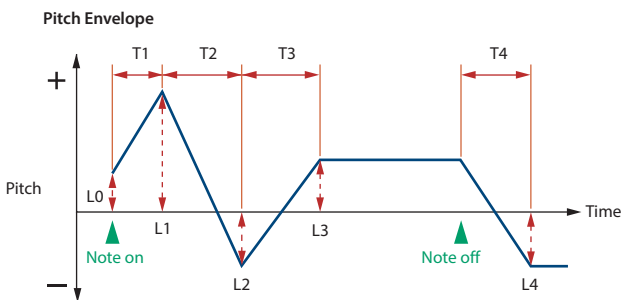
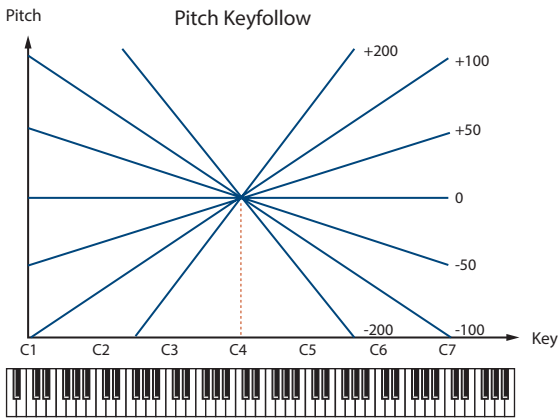

TVF

PATCH TVF

A filter cuts or boosts a specific frequency region to change a sound's brightness, thickness, or other qualities.

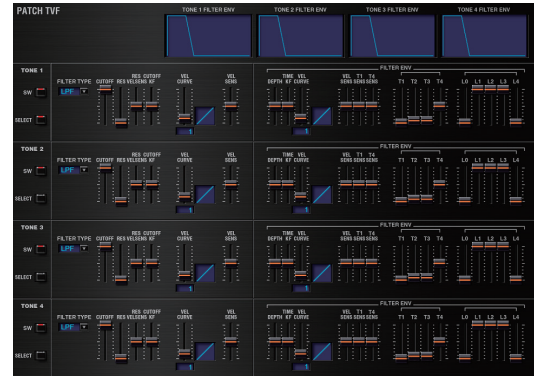

Parameter marked with a "★" can be controlled using specified MIDI messages (Matrix Control, p. 26).

Parameter	Range/Explanation
FILTER TYPE	<p>Type of filter</p> <ul style="list-style-type: none"> OFF: No filter is used. LPF: Low Pass Filter. This reduces the volume of all frequencies above the Cutoff Frequency in order to round off, or un-brighten the sound. BPF: Band Pass Filter. This leaves only the frequencies in the region of the Cutoff Frequency, and cuts the rest. This can be useful when creating distinctive sounds. HPF: High Pass Filter. This cuts the frequencies in the region below the Cutoff Frequency. This is suitable for creating percussive sounds emphasizing their higher tones. PKG: Peaking Filter. This emphasizes the frequencies in the region of the Cutoff Frequency. You can use this to create wah-wah effects by employing an LFO to change the Cutoff Frequency cyclically. LPF2: Low Pass Filter 2. Although frequency components above the Cutoff Frequency are cut, the sensitivity of this filter is half that of the LPF. This filter is good for use with simulated instrument sounds such as the acoustic piano. LPF3: Low Pass Filter 3. Although frequency components above the Cutoff Frequency are cut, the sensitivity of this filter changes according to the Cutoff Frequency. While this filter is also good for use with simulated acoustic instrument sounds, the nuance it exhibits differs from that of the LPF2, even with the same TVF Envelope settings. <p>* If you set "LPF2" or "LPF3," the setting for the RES parameter will be ignored.</p>
CUTOFF ★ (Cutoff Frequency)	0-127 Frequency at which the filter begins to have an effect on the waveform's frequency components
RES ★ (Resonance)	0-127 Emphasizes the portion of the sound in the region of the cutoff frequency, adding character to the sound * Excessively high settings can produce oscillation, causing the sound to distort.
RES VEL SENS (Resonance Velocity Sens)	-63-+63 This allows keyboard velocity to modify the amount of Resonance. If you want strongly played notes to have a greater Resonance effect, set this parameter to positive (+) settings.

Parameter	Range/Explanation
CUTOFF KF (Cutoff Keyfollow)	-200--+200 Use this parameter if you want the cutoff frequency to change according to the key that is pressed Relative to the cutoff frequency at the C4 key (center C), positive (+) settings will cause the cutoff frequency to rise for notes higher than C4, and negative (-) settings will cause the cutoff frequency to fall for notes higher than C4. Larger settings will produce greater change.

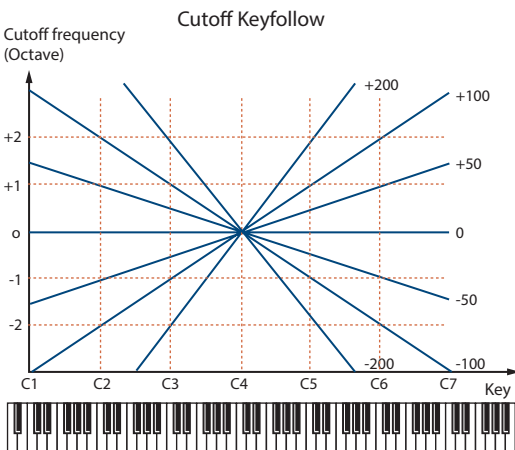
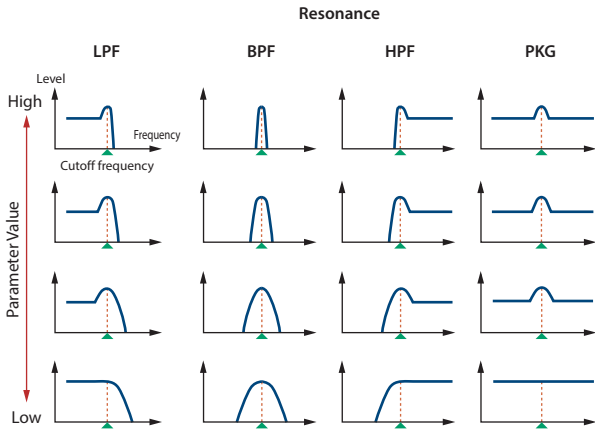

Parameter	Range/Explanation
VEL CURVE (Cutoff Velocity Curve)	FIX, 1-7 Curve that determines how keyboard playing dynamics (velocity) will affect the cutoff frequency Set this to "FIX" if you don't want the Cutoff frequency to be affected by the keyboard velocity.
VEL SENS (Cutoff Velocity Sens)	-63--+63 Use this parameter when changing the cutoff frequency to be applied as a result of changes in playing velocity. If you want strongly played notes to raise the cutoff frequency, set this parameter to positive (+) settings.

FILTER ENV (TVF ENVELOPE)

Parameter marked with a "★" can be controlled using specified MIDI messages (Matrix Control, p. 26).

Parameter	Range/Explanation
DEPTH	-63--+63 Depth of the TVF envelope Higher settings will cause the TVF envelope to produce greater change. Negative (-) settings will invert the shape of the envelope.
TIME KF (Time Keyfollow)	-100--+100 Use this setting if you want the TVF envelope times (T2-T4) to be affected by the keyboard location. Based on the TVF envelope times for the C4 key (center C), positive (+) settings will cause notes higher than C4 to have increasingly shorter times.
VEL CURVE (Velocity Curve)	FIX, 1-7 Curve that determines how keyboard playing dynamics (velocity) will affect the TVF envelope Set this to "FIX" if you don't want the TVF Envelope to be affected by the keyboard velocity.
VEL SENS (Velocity Sens)	-63--+63 Specifies how keyboard playing dynamics will affect the depth of the TVF envelope. Positive (+) settings will cause the TVF envelope to have a greater effect for strongly played notes, and negative (-) settings will cause the effect to be less.
T1 SENS	-63--+63 This allows keyboard dynamics to affect the T1 of the TVF envelope. If you want T1 to be speeded up for strongly played notes, set this parameter to a positive (+) value.
T4 SENS	-63--+63 Use this parameter when you want key release speed to affect the T4 value of the TVF envelope. If you want T4 to be speeded up for quickly released notes, set this parameter to a positive (+) value.
T1-4 ★ (Time 1-4)	0-127 TVF envelope times (T1-T4) Higher settings will lengthen the time until the next cutoff frequency level is reached.
L0-4 (Level 0-4)	0-127 TVF envelope levels (L0-L4) Specify how the cutoff frequency will change at each point, relative to the Cutoff Frequency value.

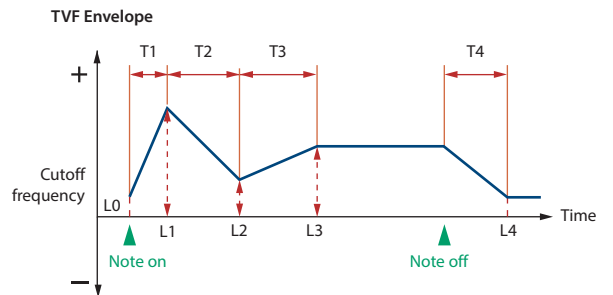

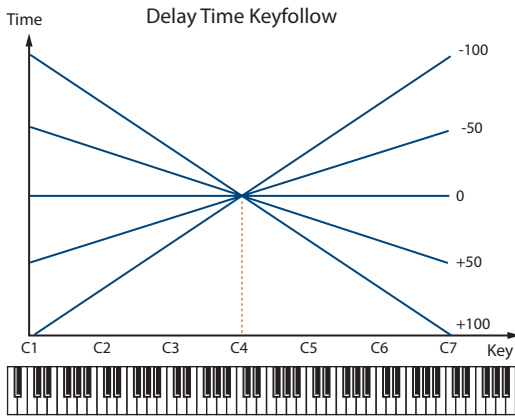

TVA

PATCH TVA

TVA adjusts the volume.

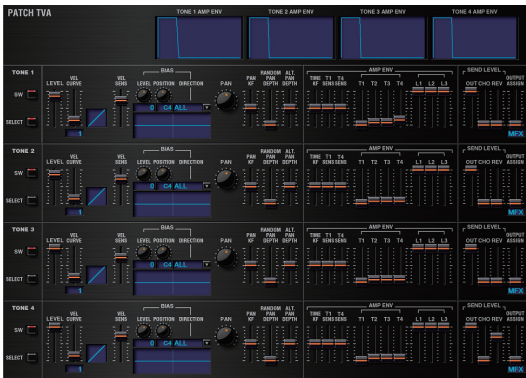

Parameter marked with a "★" can be controlled using specified MIDI messages (Matrix Control, p. 26).

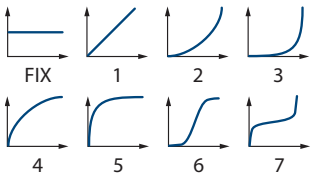
Parameter	Range/Explanation
LEVEL ★	0-127 Volume of the tone This setting is useful primarily for adjusting the volume balance between tones.
VEL CURVE (Velocity Curve)	FIX, 1-7 Curve that determines how keyboard playing dynamics (velocity) will affect the volume Set this to "FIX" if you don't want the volume of the tone to be affected by the keyboard velocity. 
VEL SENS (Velocity Sens)	-63-+63 Set this when you want the volume of the tone to change depending on keyboard playing dynamics Set this to a positive (+) value to have the changes in tone volume increase the more forcefully the keys are played; to make the tone play more softly as you play harder, set this to a negative (-) value.

Parameter	Range/Explanation
BIAS (*1)	LEVEL -100-+100 Angle of the volume change that will occur in the selected Bias Direction Larger settings will produce greater change. Negative (-) values will invert the change direction.
	POSITION C-1-G9 Key relative to which the volume will be modified
	DIRECTION Direction in which change will occur starting from the Bias Position LOWER: The volume will be modified for the keyboard area below the Bias Position. UPPER: The volume will be modified for the keyboard area above the Bias Position. LO&UP: The volume will be modified symmetrically toward the left and right of the Bias Position. ALL: The volume changes linearly with the Bias Position at the center.

*1 Bias causes the volume to be affected by the keyboard position. This is useful for changing volume through keyboard position (pitch) when playing acoustic instruments.

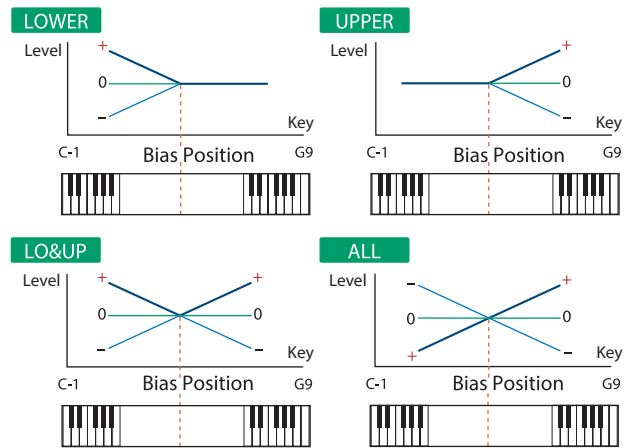

Parameter	Range/Explanation
PAN ★	L64-0-63R Left/right position of the tone
PAN KF (Pan Keyfollow)	-100-+100 Use this parameter if you want key position to affect panning. Positive (+) settings will cause notes higher than C4 key (center C) to be panned increasingly further toward the right, and negative (-) settings will cause notes higher than C4 key (center C) to be panned toward the left. Larger settings will produce greater change.
RANDOM PAN DEPTH	0-63 Use this parameter when you want the stereo location to change randomly each time you press a key. Higher settings will produce a greater amount of change.

Parameter	Range/Explanation
ALT. PAN DEPTH (Alternate Pan Depth)	L63-0-63R This setting causes panning to be alternated between left and right each time a key is pressed. Higher settings will produce a greater amount of change. "L" or "R" settings will reverse the order in which the pan will alternate between left and right. For example if two tones are set to "L" and "R" respectively, the panning of the two tones will alternate each time they are played.

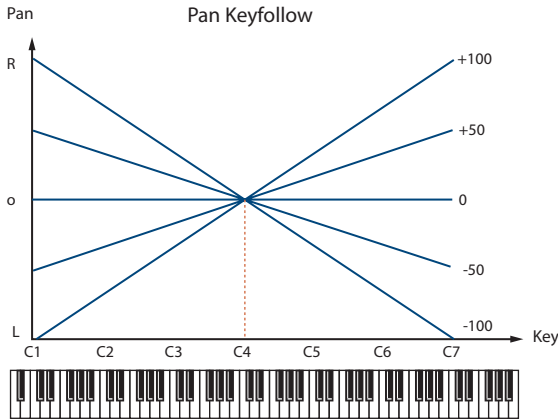

* When a TYPE 02-10 has been selected for STRUCTURE (p. 15), the settings for PAN KF, RANDOM PAN DEPTH, and ALT. PAN DEPTH for tone 1 (3) will be in concord with the settings for tone 2 (4). (This is because the outputs of tones 1 and 2 are consolidated in tone 2, and the outputs of tones 3 and 4 are consolidated in tone 4.)

AMP ENV (TVA ENVELOPE)

Parameter marked with a "★" can be controlled using specified MIDI messages (Matrix Control, p. 26).

Parameter	Range/Explanation
TIME KF (TIME Keyfollow)	-100-+100 Use this setting if you want the TVA envelope times (T2-T4) to be affected by the keyboard location. Based on the TVA envelope times for the C4 key (center C), positive (+) settings will cause notes higher than C4 to have increasingly shorter times, and negative (-) settings will cause them to have increasingly longer times. Larger settings will produce greater change.
T1 SENS	-63-+63 This allows keyboard dynamics to affect the T1 of the TVA envelope. If you want Time 1 to be speeded up for strongly played notes, set this parameter to a positive (+) value. If you want it to be slowed down, set this to a negative (-) value.
T4 SENS	-63-+63 Use this parameter when you want key release speed to affect the T4 value of the TVA envelope. If you want T4 to be speeded up for quickly released notes, set this parameter to a positive (+) value. If you want it to be slowed down, set this to a negative (-) value.
T1-4 ★ (Time 1-4)	0-127 TVA envelope times (T1-T4) Higher settings will lengthen the time until the next volume level is reached.

Parameter	Range/Explanation
L1-3 (Level 1-3)	0-127 TVA envelope levels (L1-L3) Specifies the volume at each point.

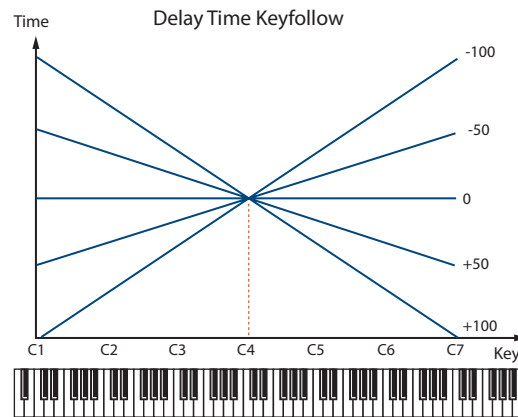
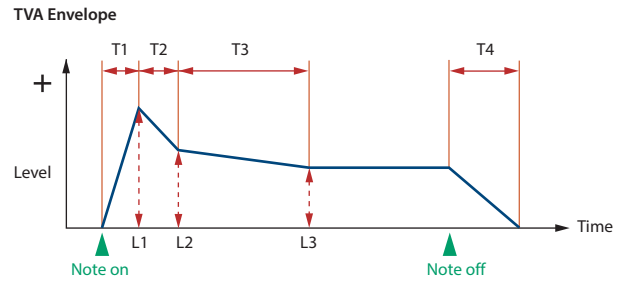

OUTPUT

Parameter	Range/Explanation
SEND LEVEL OUT (Output Level)	0-127 Level of the signal that is sent to the output destination specified by OUTPUT ASSIGN
SEND LEVEL (OUTPUT ASSIGN = MFX)	
CHO (Chorus Send)	0-127 Level of the signal sent to chorus for each tone if the tone is sent through MFX
REV (Reverb Send)	0-127 Level of the signal sent to reverb for each tone if the tone is sent through MFX
SEND LEVEL (OUTPUT ASSIGN = non MFX)	
CHO (Chorus Send)	0-127 Level of the signal sent to chorus for each tone if the tone is not sent through MFX
REV (Reverb Send)	0-127 Level of the signal sent to reverb for each tone if the tone is not sent through MFX

Parameter	Range/Explanation
OUTPUT ASSIGN	<p>Specifies how the direct sound of each tone will be output.</p> <p>MFx: Output in stereo through multi-effects. You can also apply chorus or reverb to the sound that passes through multi-effects.</p> <p>L+R: Output in stereo to the OUTPUT without passing through the multi-effect</p> <p>L: Output in mono to the OUTPUT L without passing through the multi-effect</p> <p>R: Output in mono to the OUTPUT R without passing through the multi-effect</p> <p>* If the PATCH OUTPUT ASSIGN is set to anything other than "TONE," these settings will be ignored.</p> <p>* If "STRUCTURE" (p. 15) is set to TYPE 02–10, the settings for tone 1 (3) will follow the settings of tone 2 (4). (This is because the outputs of tones 1 and 2 are combined into tone 2, and the outputs of tones 3 and 4 are combined into tone 4.)</p> <p>* Sounds are output to chorus and reverb in mono at all times.</p> <p>* The output destination of the signal after passing through the chorus is set with the CHORUS OUTPUT SELECT (p. 34).</p>

LFO

An LFO (Low Frequency Oscillator) causes change over a cycle in a sound. Each tone has two LFOs (LFO1/LFO2), and these can be used to cyclically change the pitch, cutoff frequency and volume to create modulation-type effects such as vibrato, wah and tremolo. Both LFOs have the same parameters so only one explanation is needed.

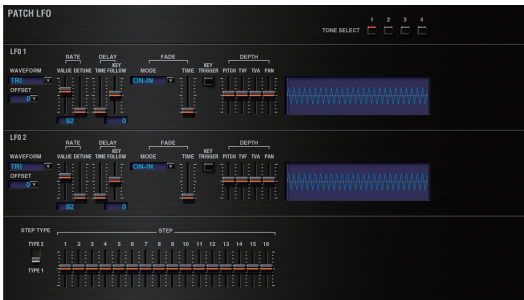

PATCH LFO

LFO 1/LFO 2

Parameter marked with a "★" can be controlled using specified MIDI messages (Matrix Control, p. 26).

Parameter	Range/Explanation
WAVEFORM	<p>Waveform of the LFO</p> <p>SIN: Sine wave</p> <p>TRI: Triangle wave</p> <p>SAW-UP: Sawtooth wave</p> <p>SAW-DW: Sawtooth wave (negative polarity)</p> <p>SQR: Square wave</p> <p>RND: Random wave</p> <p>BEND-UP: Once the attack of the waveform output by the LFO is allowed to develop in standard fashion, the waveform then continues without further change.</p> <p>BEND-DW: Once the decay of the waveform output by the LFO is allowed to develop in standard fashion, the waveform then continues without further change.</p> <p>TRP: Trapezoidal wave</p> <p>S&H: Sample & Hold wave (holds a random value during each cycle)</p> <p>CHS: Chaos wave</p> <p>VSIN: Modified sine wave. The amplitude of a sine wave is randomly varied once each cycle.</p> <p>STEP: A waveform generated by the data specified by LFO Step 1–16. This produces stepped change with a fixed pattern similar to a step modulator.</p> <p>* If you set this to "BEND-UP" or "BEND-DW" you must turn the KEY TRIGGER parameter (p. 24) to "ON." If this is "OFF," it will have no effect.</p>
OFFSET	<p>-100–+100</p> <p>Raises or lowers the LFO waveform relative to the central value (pitch or cutoff frequency). Positive (+) settings will move the waveform so that modulation will occur from the central value upward. Negative (-) settings will move the waveform so that modulation will occur from the central value downward.</p>
RATE VALUE ★	<p>0–127, Note</p> <p>Modulation speed of the LFO</p> <p>If you want the LFO rate to be synchronized with the tempo, this should be set in terms of a note value.</p> <p>* This setting will be ignored if the Waveform parameter is set to "CHS."</p>
RATE DETUNE	<p>0–127</p> <p>Makes subtle changes in the LFO cycle rate (Rate parameter) each time a key is pressed. Higher settings will cause greater change.</p> <p>* This parameter is invalid when RATE VALUE is set to "note."</p>
DELAY TIME	<p>0–127</p> <p>Time elapsed before the LFO effect is applied (the effect continues) after the key is pressed (or released)</p> <p>When using violin, wind, or certain other instrument sounds in a performance, rather than having vibrato added immediately after the sounds are played, it can be effective to add the vibrato after the note is drawn out somewhat.</p> <p>* Set this according to your purpose as described in "How to Apply the LFO" (p. 24).</p>

Parameter	Range/Explanation
DELAY KEYFOLLOW (Delay Time Keyfollow)	-100--+100 Adjusts the value for the DELAY TIME parameter depending on the key position, relative to the C4 key (center C). If this is set to a positive "+" value, the DELAY TIME will become shorter as you play notes higher than the C4 key (middle C).

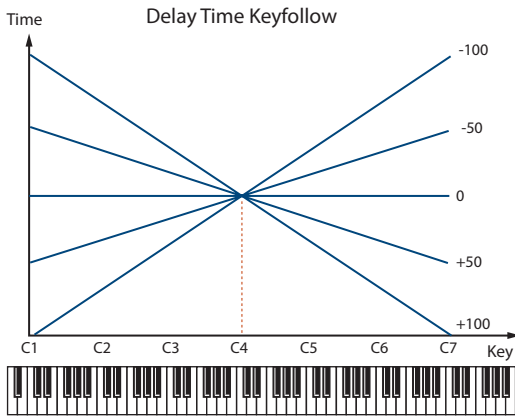

Parameter marked with a "★" can be controlled using specified MIDI messages (Matrix Control, p. 26).

Parameter	Range/Explanation
FADE MODE	ON-IN, ON-OUT, OFF-IN, OFF-OUT How the LFO will be applied * Set this according to your purpose as described in "How to Apply the LFO" (p. 24).
FADE TIME	0-127 Time over which the LFO amplitude will reach the maximum (minimum) * Set this according to your purpose as described in "How to Apply the LFO" (p. 24).
KEY TRIGGER	OFF, ON Specifies whether the LFO cycle will be synchronized to begin when the key is pressed (ON) or not (OFF).
DEPTH PITCH ★	-63--+63 How deeply the LFO will affect pitch
DEPTH TVF ★	-63--+63 How deeply the LFO will affect the cutoff frequency
DEPTH TVA ★	-63--+63 How deeply the LFO will affect the volume
DEPTH PAN ★	-63--+63 How deeply the LFO will affect the pan

Positive (+) and negative (-) settings for the DEPTH parameters result in differing kinds of change in pitch and volume. For example, if you set the DEPTH parameter to a positive (+) value for one tone, and set another tone to the same numerical value, but make it negative (-), the modulation phase for the two tones will be the reverse of each other. This allows you to shift back and forth between two different tones, or combine it with the Pan setting to cyclically change the location of the sound image.

* If "STRUCTURE" (p. 15) is set to TYPE 02-10, the settings for tone 1 (3) will follow the settings of tone 2 (4). (This is because the outputs of tones 1 and 2 are combined into tone 2, and the outputs of tones 3 and 4 are combined into tone 4.)

How to Apply the LFO

Apply the LFO gradually after the key is pressed

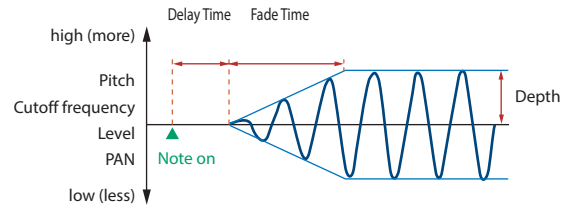

- FADE MODE:** ON-IN
- DELAY TIME:** Time from when the keyboard is played until the LFO begins to be applied
- FADE TIME:** Time over which the LFO amplitude will reach the maximum after the DELAY TIME has elapsed

Apply the LFO immediately when the key is pressed, and then gradually begin to decrease the effect

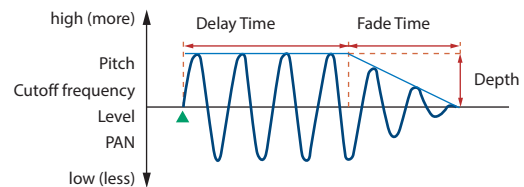

- FADE MODE:** ON-OUT
- DELAY TIME:** Time that the LFO will continue after the keyboard is played
- FADE TIME:** Time over which the LFO amplitude will reach the minimum after the DELAY TIME has elapsed

Apply the LFO gradually after the key is released

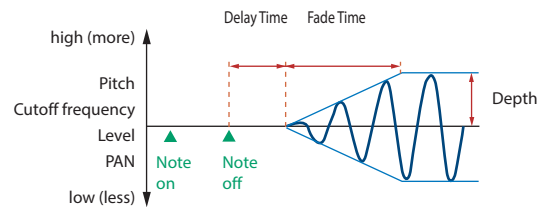

- FADE MODE:** OFF-IN
- DELAY TIME:** Time from when the keyboard is released until the LFO begins to be applied
- FADE TIME:** Time over which the LFO amplitude will reach the maximum after the DELAY TIME has elapsed

Apply the LFO from when the key is pressed until it is released, and gradually begin to decrease the effect when the key is released

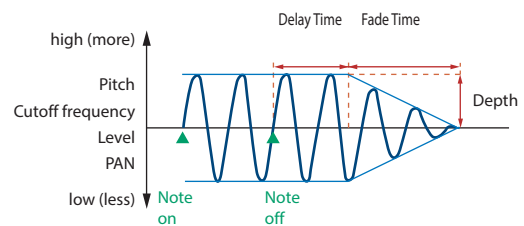

- FADE MODE:** OFF-OUT
- DELAY TIME:** Time that the LFO will continue after the keyboard is released
- FADE TIME:** Time over which the LFO amplitude will reach the minimum after the DELAY TIME has elapsed

STEP LFO

Parameter	Range/Explanation
STEP TYPE	When generating an LFO waveform from the data specified in LFO Step 1–16, specify whether the level will change abruptly at each step or will be connected linearly. TYPE1: stair-step change TYPE2: linear change
STEP 1–16	-36–+36 Specifies the data for the Step LFO. If the LFO PITCH DEPTH is +63, each +1 unit of the step data corresponds to a pitch of +50 cents.

VELOCITY & KEY RANGE

PATCH VELOCITY RANGE

You can use the force with which keys are played to control the way each Tone is played.

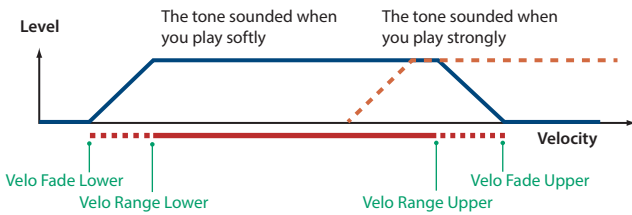

Parameter	Range/Explanation
VELOCITY CONTROL	OFF, ON, RANDOM, CYCLE Determines whether a different tone is played (ON) or not (OFF) depending on the force with which the key is played (velocity). RANDOM: The patch's constituent tones will sound randomly, regardless of any Velocity. CYCLE: The patch's constituent tones will sound consecutively, regardless of any Velocity.
TMT CONTROL SW	OFF, ON Use the Matrix Control (p. 26) to enable (ON), or disable (OFF) sounding of different tones.
FADE LOWER	0–127 Determines what will happen to the tone's level when the tone is played at a velocity lower than Velocity Range Lower. If you don't want the tone to sound at all, set this parameter to "0."
LOWER	1– (UPPER) Specifies the lowest velocity at which the tone will sound.
UPPER	(LOWER) –127 Specifies the highest velocity at which the tone will sound.
FADE UPPER	0–127 Determines what will happen to the tone's level when the tone is played at a velocity greater than Velocity Range Upper. If you don't want the tone to sound at all, set this parameter to "0."

MEMO

When using the Matrix Control to have different tones played, set the lowest value (LOWER) and highest value (UPPER) of the value of the MIDI message used.

NOTE

Instead of using Velocity, you can also have tones substituted using the Matrix Control. However, the keyboard velocity and the Matrix Control cannot be used simultaneously to make different tones to sound. When using the Matrix Control to switch tones, set the VELOCITY CONTROL parameter to "OFF"

PATCH KEY RANGE

You can use the note number to control the way each Tone is played.

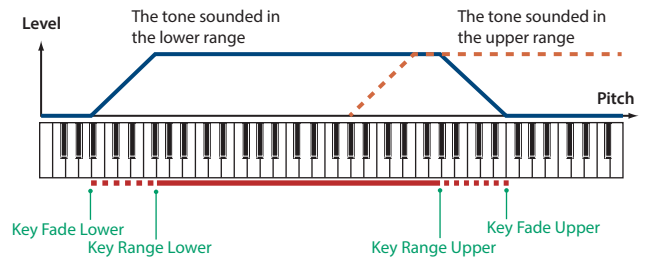
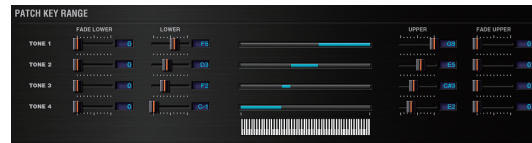

Parameter	Range/Explanation
FADE LOWER	0–127 Determines what will happen to the tone's level when a note that's lower than Key Range Lower is played. If you don't want the tone to sound at all, set this parameter to "0."
LOWER	C-1– (UPPER) Specifies the lowest note that the tone will sound for each tone.
UPPER	(LOWER) –G9 Specifies the highest note that the tone will sound for each tone.
FADE UPPER	0–127 Determines what will happen to the tone's level when a note that's higher than Key Range Upper is played. If you don't want the tone to sound at all, set this parameter to "0."

MATRIX CONTROL

The function which allows you use MIDI messages to make changes in realtime to the tone parameters is called the Matrix Control. Up to four Matrix Controls can be used in a single patch.

To use the Matrix Control, specify which MIDI message (SOURCE) will be used to control which parameter (DESTINATION), and how greatly (SENS), and the tone to which the effect is applied (TONE).

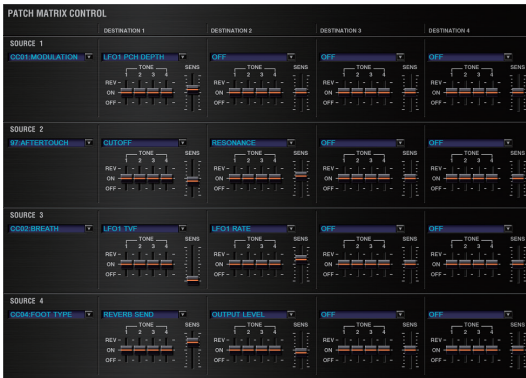

Parameter	Range/Explanation
SOURCE 1-4	<p>MIDI message used to change the tone parameter with the Matrix Control</p> <p>OFF: Matrix control will not be used.</p> <p>CC01-31, 33-95: Controller numbers 1-31, 33-95</p> <p>PITCH BEND: Pitch Bend</p> <p>AFTERTOUCH: Aftertouch</p> <p>VELOCITY: Pressure you press a key with</p> <p>KEYFOLLOW: Keyboard position with C4 as 0</p> <p>TEMPO: The tempo of the DAW</p> <p>LFO1: LFO 1</p> <p>LFO2: LFO 2</p> <p>PITCH ENV: Pitch envelope</p> <p>TVF ENV: TVF envelope</p> <p>TVA ENV: TVA envelope</p>

MEMO

- VELOCITY and KEYFOLLOW correspond to Note messages.
- Although there are no MIDI messages for LFO 1 through TVA Envelope, they can be used as Matrix Control. In this case, you can change the tone settings in realtime by playing patches.

NOTE

If RCV BENDER, RCV EXP, or RCV HOLD-1 (p. 26-p. 27) are **"ON,"** incoming MIDI messages of these types will affect the Pitch Bend, Expression, or Hold 1 settings at the same time that they affect the target parameter (DESTINATION). If you want these incoming messages to affect only the target parameter, turn these settings **"OFF."**

Parameter	Range/Explanation
DESTINATION 1-4	<p>OFF, PITCH, CUTOFF, RESONANCE, LEVEL, PAN, OUTPUT LEVEL, CHORUS SEND, REVERB SEND, LFO1/2 PCH DEPTH, LFO1/2 TVF DEPTH, LFO1/2 TVA DEPTH, LFO1/2 PAN DEPTH, LFO1/2 RATE, PCH ENV A-TIME, PCH ENV D-TIME, PCH ENV R-TIME, TVF ENV A-TIME, TVF ENV D-TIME, TVF ENV R-TIME, TVA ENV A-TIME, TVA ENV D-TIME, TVA ENV R-TIME, TMT, FXM DEPTH, MFX-CTRL 1-4</p> <p>Tone parameters that are to be controlled when using the Matrix Control Up to four parameters can be specified for each Matrix Control, and controlled simultaneously.</p> <p>* In this manual, parameters that can be controlled using the Matrix Control are marked with a "★."</p>
SENS 1-4	<p>-63-+63</p> <p>Amount of the Matrix Control's effect that is applied</p> <p>If you wish to modify the selected parameter in a positive (+) direction—i.e., a higher value, toward the right, or faster etc.—from its current setting, select a positive (+) value.</p> <p>If you wish to modify the selected parameter in a negative (-) direction—i.e., a lower value, toward the left, or slower etc.—from its current setting, select a negative (-) value.</p> <p>For either positive or negative settings, greater absolute values will allow greater amounts of change. Set this to "0" if you don't want to apply the effect.</p>
TONE 1-4 (Tone Switch 1-4)	<p>Tone to which the effect is applied when using the Matrix Control</p> <p>OFF: The effect will not be applied.</p> <p>ON: The effect will be applied.</p> <p>REV: The effect will be applied in reverse.</p>

CONTROL SW

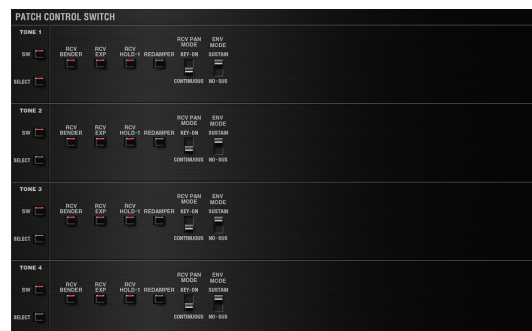

Parameter	Range/Explanation
RCV BENDER (Receive Bender)	<p>OFF, ON</p> <p>For each tone, specify whether MIDI Pitch Bend messages will be received (ON), or not (OFF).</p>
RCV EXP (Receive Expression)	<p>OFF, ON</p> <p>For each tone, specify whether MIDI Expression messages will be received (ON), or not (OFF).</p>

Parameter	Range/Explanation
RCV HOLD-1 (Receive Hold-1)	<p>OFF, ON</p> <p>For each tone, specify whether MIDI Hold-1 messages will be received (ON), or not (OFF).</p> <p>* If "NO-SUS" is selected for ENV MODE parameter, this setting will have no effect.</p>
REDAMPER	<p>OFF, ON</p> <p>You can specify, on an individual tone basis, whether or not the sound will be held when a Hold 1 message is received after a key is released, but before the sound has decayed to silence.</p> <p>If you want to sustain the sound, set this "ON." This function is effective for piano sounds.</p> <p>* In order to use this function, you must also set RCV HOLD-1 to "ON."</p>
RCV PAN MODE (Receive Pan Mode)	<p>CONTINUOUS, KEY-ON</p> <p>For each tone, specify how pan messages will be received.</p> <p>CONTINUOUS: Whenever Pan messages are received, the stereo position of the tone will be changed.</p> <p>KEY-ON: The pan of the tone will be changed only when the next note is played. If a pan message is received while a note is sounding, the panning will not change until the next key is pressed.</p> <p>* The channels cannot be set so as not to receive Pan messages.</p>
ENV MODE (Envelope Mode)	<p>NO-SUS, SUSTAIN</p> <p>When a loop waveform (p. 12) is selected, the sound will normally continue as long as the key is pressed. If you want the sound to decay naturally even if the key remains pressed, set this to "NO-SUS."</p> <p>* If a one-shot type wave (p. 12) is selected, it will not sustain even if this parameter is set to "SUSTAIN."</p>

Detailed Editing for a Rhythm Set (RHYTHM Parameters)

How to Edit a Rhythm Set

You can create a new rhythm set by editing an existing rhythm set. A rhythm set is a collection of rhythm keys (percussion instrument sounds). To edit a rhythm set, you need to edit the settings of the rhythm key assigned to each key.

The rhythm key assigned to each key consists of up to four waves. The relationship between rhythm keys and waves is the same as the relationship between patches and tones.

Copying/Pasting Rhythm Parameters

You can select and copy a portion of the rhythm parameters (such as a rhythm key or MFx), and then paste those parameters to another rhythm key or another patch.

1. In the main window, click the [UTILITY] button.

A popup appears.

Item	Explanation
Initialize	Initializes the settings of the patch or rhythm set. This is convenient when you want to create data from scratch.
Copy	Copies the selected parameter from the currently selected patch or rhythm set to the clipboard.
Paste	Pastes the selected parameter from the clipboard to the current patch or rhythm set.

2. Select "Initialize", "Copy" or "Paste."

A list of the items that can be initialized or copied, or a list of the destinations to which data can be written, appears.

3. In the list, click to select the desired item.

WG

Use TONE SWITCH (SW) 1–4 to turn each of the four waves on/off.

Use TONE SELECT 1–4 to select the wave that you want to edit.



- You can select multiple waves by clicking a TONE SWITCH button while holding down the computer's Shift key.
- You can select all waves by holding down the computer's Command (Ctrl) key and clicking a TONE SWITCH button.
- When you edit the settings of a wave, the settings of the currently selected waves will change simultaneously.
- Unselected waves can be edited independently.

Stereo Wave Settings (Set Stereo Function)

Some of the waves that make up a rhythm set key are stereo. With stereo waves, the name of a left-channel wave ends in "L", while the name of a right-channel wave ends in "R".

The left and right waves are numbered consecutively; the right-channel wave number is one greater than the left-channel wave number.

You can use the following procedure to first select either the left or right wave, and then select the other wave.

1. Select a rhythm set.
2. In the navigation window, make sure that [WG] is selected.
3. In WAVE NUMBER L, select the wave that is the left side of the stereo wave.
4. While holding down the Command (Ctrl) key, click on WAVE NUMBER R.

The corresponding right-channel wave will be selected.

MEMO

After selecting the right-channel wave in WAVE NUMBER R, you can also hold down the Command (Ctrl) key and click on WAVE NUMBER L to select the left-channel wave.

If the wave is not a stereo wave, the selection won't change.

RHYTHM Parameters

COMMON

RHYTHM KEY NAME



Parameter	Range/Explanation
KEY NAME	Name of the rhythm key assigned to each key

RHYTHM COMMON



Parameter	Range/Explanation
RHYTHM NAME	Rhythm set name
LEVEL	0–127 Volume of the rhythm set
OUTPUT ASSIGN	Specifies how the unprocessed sound of the patch (rhythm set) will be output MFx : Output in stereo via the multi-effect. Chorus and reverb can also be applied after the multi-effect. L+R : Output in stereo from the OUTPUT without passing through the multi-effect L : Output in mono from the OUTPUT L without passing through the multi-effect R : Output in mono from the OUTPUT R without passing through the multi-effect TO : Output according to the settings of each tone
MASTER TUNE	415.3–466.2 Hz Overall tuning of the SRX WORLD The display shows the frequency of the A4 note (center A).

RHYTHM KEY CONTROL



Parameter	Range/Explanation
RHYTHM KEY NAME	Name of the rhythm key assigned to each key
PITCH BEND RANGE	0–48 Amount of pitch change that occurs when the pitch bend controller is at the maximum/minimum position (semitone units, maximum of four octaves)
MUTE GROUP	OFF, 1–31 The Mute Group function allows you to designate two or more rhythm keys that are not allowed to sound simultaneously. On an actual acoustic drum set, an open hi-hat and a closed hi-hat sound can never occur simultaneously. To reproduce the reality of this situation, you can set up a Mute Group. Up to 31 Mute Groups can be used. rhythm keys that are not belong to any such group should be set to "OFF."

Parameter	Range/Explanation
ASSIGN TYPE	Sets the way sounds are played when the same key is pressed a number of times. SINGLE : Only one sound can be played at a time when the same key is pressed. With continuous sounds where the sound plays for an extended time, the previous sound is stopped when the following sound is played. MULTI : Layer the sound of the same keys. Even with continuous sounds where the sound plays for an extended time, such as with crash cymbals, the sounds are layered, without previously played sounds being eliminated.
ENV MODE	NO-SUS, SUSTAIN When a loop waveform (p. 12) is selected, the sound will normally continue as long as the key is pressed. If you want the sound to decay naturally even if the key remains pressed, set this to "NO-SUS." * If a one-shot type wave (p. 12) is selected, it will not sustain even if this parameter is set to "SUSTAIN."
ONESHOT MODE	OFF, ON ON : The sound will play back until the end of the waveform (or the end of the envelope, whichever comes first) even key is released.
RCV EXP. (Receive Expression)	OFF, ON For each rhythm key, specify whether MIDI Expression messages will be received (ON), or not (OFF).
RCV HOLD-1 (Receive Hold-1)	OFF, ON For each rhythm key, specify whether MIDI Hold-1 messages will be received (ON), or not (OFF). * If "NO-SUS" is selected for ENV MODE parameter, this setting will have no effect.
RCV PAN MODE (Receive Pan Mode)	For each rhythm key, specify how pan messages will be received. CONTINUOUS : Whenever Pan messages are received, the stereo position of the tone will be changed. KEY-ON : The pan of the tone will be changed only when the next note is played. If a pan message is received while a note is sounding, the panning will not change until the next key is pressed. * The channels cannot be set so as not to receive Pan messages.

WG

RHYTHM KEY WG

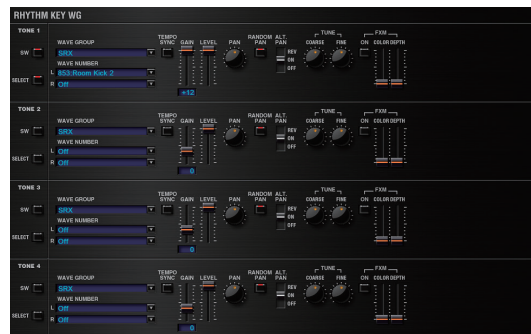

Parameter	Range/Explanation
Wave Group	Selects the group for the waveform that is to be the basis of the tone. Standard : Basic wave group SRX : SRX wave group
WAVE NUMBER L / R	Waves comprising the rhythm key When in monaural mode, only the left side (L) is specified. When in stereo, the right side (R) is also specified. "Set Stereo function" To select a left/right pair of waveforms, select the left (L) WAVE No., and then hold down the Command (Ctrl) key and click the right (R) WAVE No. to recall the right (R) WAVE.

Parameter	Range/Explanation
TEMPO SYNC	OFF, ON Turn this "ON" if you want the Phrase Loop to match the tempo of the DAW.
GAIN	-6, 0, +6, +12 Gain (amplification) of the waveform The value changes in 6 dB (decibel) steps—an increase of 6 dB doubles the waveform's gain.
LEVEL	0–127 Volume of the waveform
PAN	L64–0–63R Left/right position of the waveform
RANDOM PAN	OFF, ON Use this setting to cause the waveform's panning to change randomly each time a key is pressed (ON) or not (OFF). The range of the panning change is set by the RANDOM PAN DEPTH parameter (p. 32).
ALT. PAN (Alternate Pan)	OFF, ON, REV This setting causes panning of the waveform to be alternated between left and right each time a key is pressed. Set this to "ON" to pan the wave according to the ALT. PAN DEPTH parameter (p. 32) settings, or to "REV" when you want the panning reversed.
TUNE	COARSE -48–+48 Pitch of the waveform's sound (in semitones, +/-4 octaves)
	FINE -50–+50 Pitch of the waveform's sound (in 1-cent steps; one cent is 1/100th of a semitone)
FXM (*1)	ON OFF, ON This sets whether FXM will be used (ON) or not (OFF).
	COLOR 1–4 How FXM will perform frequency modulation Higher settings result in a grainier sound, while lower settings result in a more metallic sound.
	DEPTH 0–16 Depth of the modulation produced by FXM

*1 FXM (Frequency Cross Modulation) uses a specified waveform to apply frequency modulation to the currently selected waveform, creating complex overtones. This is useful for creating dramatic sounds or sound effects.

PITCH + TVF

RHYTHM KEY PITCH



Parameter	Range/Explanation
TUNE	COARSE C-1–G9 Pitch at which a rhythm key sounds Set the coarse tuning for Waves comprising the rhythm keys with the RHYTHM KEY WG TUNE COARSE parameter (p. 30).
	FINE -50–+50 Pitch of the rhythm key's sound (in 1-cent steps; one cent is 1/100th of a semitone) Set the fine tuning for Waves comprising the rhythm keys with the RHYTHM KEY WG TUNE FINE parameter (p. 30).

Parameter	Range/Explanation
RANDOM PITCH	0–1200 Width of random pitch deviation that will occur each time a key is pressed (in 1-cent steps) If you do not want the pitch to change randomly, set this to "0:"

PITCH ENV (RHYTHM KEY PITCH ENVELOPE)

Parameter	Range/Explanation
DEPTH	-12–+12 Depth of the Pitch Envelope Higher settings will cause the pitch envelope to produce greater change. Negative (-) settings will invert the shape of the envelope.
VEL SENS (Velocity Sens)	-63–+63 Keyboard playing dynamics can be used to control the depth of the pitch envelope. If you want the pitch envelope to have more effect for strongly played notes, set this parameter to a positive (+) value.
T1 SENS (T1 Velocity Sens)	-63–+63 This allows keyboard dynamics to affect the T1 of the Pitch envelope. If you want T1 to be speeded up for strongly played notes, set this parameter to a positive (+) value.
T4 SENS (T4 Velocity Sens)	-63–+63 Use this parameter when you want key release speed to affect the T4 value of the Pitch envelope. If you want T4 to be speeded up for quickly released notes, set this parameter to a positive (+) value.
T1–4 (Time 1–4)	0–127 Pitch envelope times (T1–T4) Higher settings will result in a longer time until the next pitch is reached.
L0–4 (Level 0–4)	-63–+63 Pitch envelope levels (L0–L4) Specify how the pitch will change at each point, relative to the pitch set with COARSE TUNE or FINE TUNE.

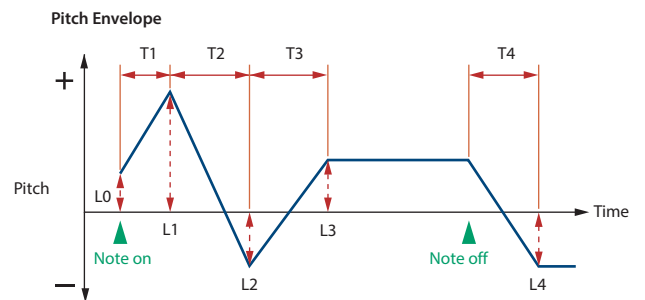

RHYTHM KEY TVF

A filter cuts or boosts a specific frequency region to change a sound's brightness, thickness, or other qualities.



Parameter	Range/Explanation
TYPE	Type of filter OFF: No filter is used. LPF: Low Pass Filter. This reduces the volume of all frequencies above the cutoff frequency in order to round off, or un-brighten the sound. BPF: Band Pass Filter. This leaves only the frequencies in the region of the cutoff frequency, and cuts the rest. This can be useful when creating distinctive sounds. HPF: High Pass Filter. This cuts the frequencies in the region below the cutoff frequency. This is suitable for creating percussive sounds emphasizing their higher tones. PKG: Peaking Filter. This emphasizes the frequencies in the region of the cutoff frequency. You can use this to create wah-wah effects by employing an LFO to change the cutoff frequency cyclically. LPF2: Low Pass Filter 2. Although frequency components above the cutoff frequency are cut, the sensitivity of this filter is half that of the LPF. This filter is good for use with simulated instrument sounds such as the acoustic piano. LPF3: Low Pass Filter 3. Although frequency components above the cutoff frequency are cut, the sensitivity of this filter changes according to the cutoff frequency. While this filter is also good for use with simulated acoustic instrument sounds, the nuance it exhibits differs from that of the LPF2, even with the same TVF Envelope settings. * If you set "LPF2" or "LPF3," the setting for the RES parameter will be ignored.
CUTOFF (Cutoff Frequency)	0-127 Frequency at which the filter begins to have an effect on the waveform's frequency components
RES (Resonance)	0-127 Emphasizes the portion of the sound in the region of the cutoff frequency, adding character to the sound. * Excessively high settings can produce oscillation, causing the sound to distort.

Parameter	Range/Explanation
RES VEL SENS (Resonance Velocity Sens)	-63--+63 This allows keyboard velocity to modify the amount of Resonance. If you want strongly played notes to have a greater Resonance effect, set this parameter to positive (+) settings.

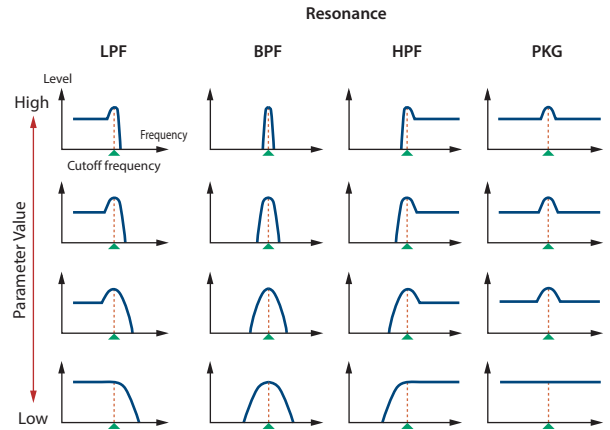

Parameter	Range/Explanation
VEL CURVE (Cutoff Velocity Curve)	FIX, 1-7 Curve that determines how keyboard playing dynamics (velocity) will affect the cutoff frequency. Set this to "FIX" if you don't want the cutoff frequency to be affected by the keyboard velocity.
VEL SENS (Cutoff Velocity Sens)	-63--+63 Use this parameter when changing the cutoff frequency to be applied as a result of changes in playing velocity. If you want strongly played notes to raise the cutoff frequency, set this parameter to positive (+) settings.

FILTER ENV (TVF ENVELOPE)

Parameter	Range/Explanation
DEPTH	-63--+63 Depth of the TVF envelope Higher settings will cause the TVF envelope to produce greater change. Negative (-) settings will invert the shape of the envelope.
VEL CURVE (Velocity Curve)	FIX, 1-7 Curve that determines how keyboard playing dynamics (velocity) will affect the TVF envelope. Set this to "FIX" if you don't want the TVF Envelope to be affected by the keyboard velocity.
VEL SENS (Velocity Sens)	-63--+63 Specifies how keyboard playing dynamics will affect the depth of the TVF envelope. Positive (+) settings will cause the TVF envelope to have a greater effect for strongly played notes, and negative (-) settings will cause the effect to be less.

Parameter	Range/Explanation
T1 SENS	-63--+63 This allows keyboard dynamics to affect the T1 of the TVF envelope. If you want T1 to be speeded up for strongly played notes, set this parameter to a positive (+) value.
T4 SENS	-63--+63 Use this parameter when you want key release speed to affect the T4 value of the TVF envelope. If you want T4 to be speeded up for quickly released notes, set this parameter to a positive (+) value.
T1-4 (Time 1-4)	0-127 TVF envelope times (T1-T4) Higher settings will lengthen the time until the next cutoff frequency level is reached.
L0-4 (Level 0-4)	0-127 TVF envelope levels (L0-L4) Specify how the cutoff frequency will change at each point, relative to the Cutoff Frequency value.

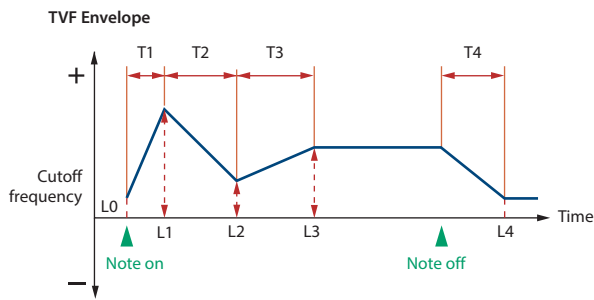

TVA + VELOCITY

RHYTHM KEY TVA

This adjusts the volume.

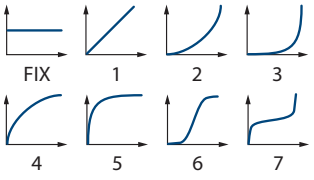

Parameter	Range/Explanation
LEVEL	0-127 Volume of the rhythm key This setting is useful primarily for adjusting the volume balance between rhythm ones.
VEL CURVE (Velocity Curve)	FIX, 1-7 Curve that determines how keyboard playing dynamics (velocity) will affect the volume of the rhythm key Set this to "FIX" if you don't want the volume of the tone to be affected by the keyboard velocity. 
VEL SENS (Velocity Sens)	-63--+63 Set this when you want the volume of the rhythm key to change depending on keyboard playing dynamics. Set this to a positive (+) value to have the changes in tone volume increase the more forcefully the keys are played; to make the tone play more softly as you play harder, set this to a negative (-) value.

Parameter	Range/Explanation
PAN	L64-0-63R Left/right position of the rhythm key
RANDOM PAN DEPTH	0-63 Use this parameter when you want the stereo location to change randomly each time you press a key. Higher settings will produce a greater amount of change.
ALT. PAN DEPTH (Alternate Pan Depth)	L63-0-63R This setting causes panning to be alternated between left and right each time a key is pressed. Higher settings will produce a greater amount of change. "L" or "R" settings will reverse the order in which the pan will alternate between left and right. For example if two rhythm keys are set to "L" and "R" respectively, the panning of the two rhythm keys will alternate each time they are played.

AMP ENV (TVA ENVELOPE)

Parameter	Range/Explanation
T1 SENS	-63--+63 This allows keyboard dynamics to affect the T1 of the TVA envelope. If you want Time 1 to be speeded up for strongly played notes, set this parameter to a positive (+) value. If you want it to be slowed down, set this to a negative (-) value.
T4 SENS	-63--+63 Use this parameter when you want key release speed to affect the T4 value of the TVA envelope. If you want T4 to be speeded up for quickly released notes, set this parameter to a positive (+) value. If you want it to be slowed down, set this to a negative (-) value.
T1-4 (Time 1-4)	0-127 TVA envelope times (T1-T4) Higher settings will lengthen the time until the next volume level is reached.
L1-3 (Level 1-3)	0-127 TVA envelope levels (L1-L3) Specify how the volume will change at each point, relative to the LEVEL value.

TVA Envelope

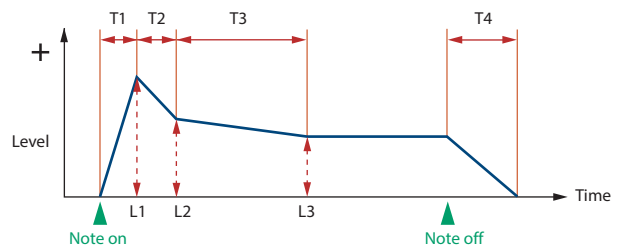

OUTPUT

Parameter	Range/Explanation
SEND LEVEL OUT (Output Level)	0-127 Level of the signal that is sent to the output destination specified by OUTPUT ASSIGN
SEND LEVEL (OUTPUT ASSIGN = MFX)	
CHO (Chorus Send)	0-127 Level of the signal sent to chorus for each rhythm key if the rhythm key is sent through MFX
REV (Reverb Send)	0-127 Level of the signal sent to reverb for each rhythm key if the rhythm key is sent through MFX
SEND LEVEL (OUTPUT ASSIGN = non MFX)	
CHO (Chorus Send)	0-127 Level of the signal sent to chorus for each rhythm key if the rhythm key is not sent through MFX

Parameter	Range/Explanation
REV (Reverb Send)	0-127 Level of the signal sent to reverb for each rhythm key if the rhythm key is not sent through MFX
OUTPUT ASSIGN	Specifies how the direct sound of each rhythm key will be output. MFX: Output in stereo through multi-effects. You can also apply chorus or reverb to the sound that passes through multi-effects. L+R: Output in stereo to the OUTPUT without passing through the multi-effect L: Output in mono to the OUTPUT L without passing through the multi-effect R: Output in mono to the OUTPUT R without passing through the multi-effect * If the OUTPUT ASSIGN in "RHYTHM COMMON" is set to anything other than "TONE," these settings will be ignored. * Sounds are output to chorus and reverb in mono at all times. * The output destination of the signal after passing through the chorus is set with the CHORUS OUTPUT SELECT parameters (p. 34).

RHYTHM KEY VELOCITY RANGE

You can use the force with which keys are played to control the way each waveform is played.

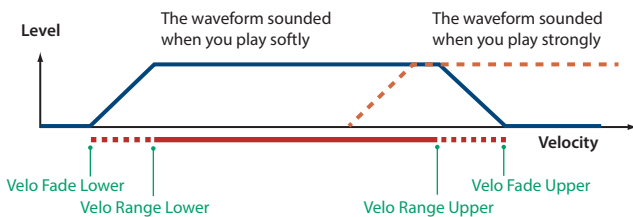
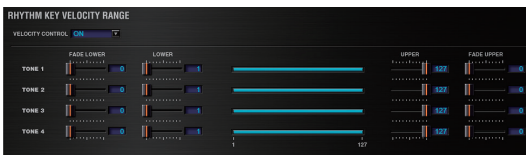

Parameter	Range/Explanation
VELOCITY CONTROL	OFF, ON, RANDOM Determines whether a different waveform is played (ON) or not (OFF) depending on the force with which the key is played (velocity). RANDOM: The rhythm key's constituent waveforms will sound randomly, regardless of any Velocity messages.
FADE LOWER	0-127 Determines what will happen to the waveform's level when the rhythm key is played at a velocity lower than Velocity Range Lower. If you don't want the waveform to sound at all, set this parameter to "0."
LOWER	1- (UPPER) Specifies the lowest velocity at which the waveform will sound.
UPPER	(LOWER) -127 Specifies the highest velocity at which the waveform will sound.
FADE UPPER	0-127 Determines what will happen to the waveform's level when the rhythm key is played at a velocity greater than Velocity Range Upper. If you don't want the waveform to sound at all, set this parameter to "0."

EFFECTS Parameters

Applying Effects

You can apply multi-effects (MFX), chorus, and reverb to each patch or rhythm set; the same effect will be applied to each tone.

By adjusting the amount of signal that is sent from each tone to each effect, you can control the depth of the effect for each tone.

Effect Settings

When you click the following buttons in the Navigation block, the content shown in the Main block will change, allowing you to edit the effect settings.

Signal Flow and Parameters (ROUTING)

Here you can make overall settings for effects, such as the output destination and level of the various signals.

PATCH EFFECTS ROUTING screen

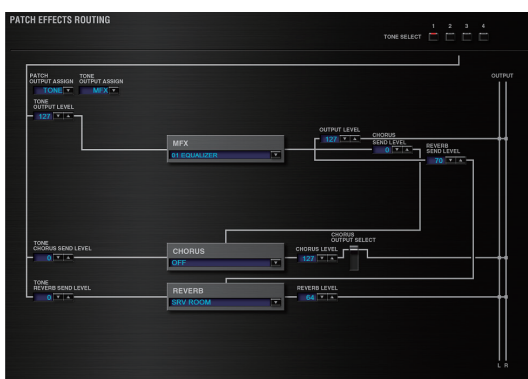

RHYTHM EFFECTS ROUTING screen

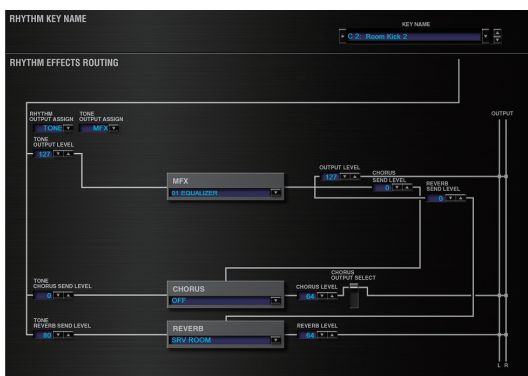

Parameter	Range/Explanation
TONE SELECT / KEY NAME	1–4 (A0–C8) The tone (rhythm key) to edit If you've selected a rhythm set, this will be KEY NAME. * You can select multiple tones by clicking a TONE SELECT button while holding down the computer's Shift key. * You can select all tones by holding down the computer's Command (Ctrl) key and clicking a TONE SELECT button.

Parameter	Range/Explanation
PATCH OUTPUT ASSIGN / RHYTHM OUTPUT ASSIGN	Specifies how the unprocessed sound of the patch (rhythm set) will be output If you've selected a rhythm set, this will be RHYTHM OUTPUT ASSIGN. MFX : Output in stereo via the multi-effect. Chorus and reverb can also be applied after the multi-effect. L+R : Output in stereo from the OUTPUT without passing through the multi-effect L : Output in mono from the OUTPUT L without passing through the multi-effect R : Output in mono from the OUTPUT R without passing through the multi-effect STONE : Output according to the settings of each tone
TONE OUTPUT ASSIGN	Specifies how the unprocessed sound of each tone will be output MFX : Output in stereo via the multi-effect. Chorus and reverb can also be applied after the multi-effect. L+R : Output in stereo from the OUTPUT without passing through the multi-effect L : Output in mono from the OUTPUT L without passing through the multi-effect R : Output in mono from the OUTPUT R without passing through the multi-effect * The setting you specify here is valid only if PATCH OUTPUT ASSIGN is set to "STONE." * If STRUCTURE (p. 15) is set to TYPE 02–10, the settings for tone 1 (3) will follow the settings of tone 2 (4). (This is because the outputs of tones 1 and 2 are combined into tone 2, and the outputs of tones 3 and 4 are combined into tone 4.)
TONE OUTPUT LEVEL	0–127 Level of signal sent from each tone to the destination specified by OUTPUT ASSIGN
TONE CHORUS SEND LEVEL	0–127 Level of signal sent from each tone to the chorus
TONE REVERB SEND LEVEL	0–127 Level of signal sent from each tone to the reverb
MFX	0–78 Type of multi-effect to use (choose one of 78 types) For details on each multi-effect, refer to "Multi-Effects Parameters (MFX)" (p. 37).
MFX OUTPUT LEVEL	0–127 Volume of the sound that has been processed by the multi-effect
MFX CHORUS SEND LEVEL	0–127 Amount of chorus applied to the sound that has been processed by the multi-effect
MFX REVERB SEND LEVEL	0–127 Amount of reverb applied to the sound that has been processed by the multi-effect
CHORUS	Type of chorus OFF : Chorus/delay will not be used CHORUS : Chorus DELAY : Delay GM2 CHORUS : GM2 chorus
CHORUS LEVEL	0–127 Volume of the sound that has been processed by the chorus
CHORUS OUTPUT SELECT	Output destination of the sound that has been processed by the chorus MAIN : Output in stereo to the OUTPUT MAIN+REV : Output in stereo to the OUTPUT and in mono to the reverb REV : Output in mono to reverb
REVERB	Type of reverb OFF : Reverb will not be used REVERB : Basic reverb SRV ROOM : Reverb that simulates the reverberation of a room in greater detail SRV HALL : Reverb that simulates the reverberation of a hall in greater detail SRV PLATE : Simulation of a plate echo (a reverb device that uses a metal plate) GM2 REVERB : GM2 reverb

Parameter	Range/Explanation
REVERB LEVEL	0–127 Volume of the sound that has been processed by the reverb

Multi-Effect Settings (MFX)



Parameter	Range/Explanation
ON/OFF	OFF, ON Turns the multi-effect on/off
TYPE	00: THROUGH-78: SYMPATHETIC RESONANCE Selects the type of multi-effect. Choose "00: THROUGH" if you don't want to apply a multi-effect.
SEND LEVEL	OUT 0–127 Volume of the sound that has been processed by the multi-effect
	CHO 0–127 Amount of chorus applied to the sound that has been processed by the multi-effect
	REV 0–127 Amount of reverb applied to the sound that has been processed by the multi-effect
Parameters of each MFX type	Edit the parameters of the MFX type you've selected. Refer to "Multi-Effects Parameters (MFX)" (p. 37).

Parameter	Range/Explanation
CONTROL SOURCE (1–4)	Specifies the MIDI message that will control the corresponding MFX control parameter. OFF : MFX Control will not be used. CC01–31 : Controller number 1–31 CC33–95 : Controller number 33–95 PITCH BEND : Pitch bend AFTERTOUCH : Aftertouch
DESTINATION (1–4)	Selects the multi-effect parameter that will be controlled by CONTROL SOURCE. The type of parameters that can be selected will depend on the type of multi-effect you've selected in MFX Type. Refer to "Multi-Effects Parameters (MFX)" (p. 37).
SENS (1–4)	-63–63 Specifies the depth of multi-effect control. Specify a positive (+) value if you want to change the value of the assigned destination in a positive direction (larger, toward the right, faster, etc.), or specify a negative value (-) if you want to change the value in a negative direction (smaller, toward the left, slower, etc.). Larger values will allow a greater amount of control.

A patch or rhythm set contains parameters that specify whether pitch bend, controller number 11 (expression), and controller number 64 (hold 1) will be received for each tone or rhythm key (p. 26, p. 29). If these settings are **"ON,"** receiving that MIDI message will not only change the setting of the assigned destination parameter, but will also apply the corresponding pitch bend, expression, or hold 1 effect. Leave them **"OFF"** if you only want to control the multi-effect parameter.

Controlling a Multi-Effect via MIDI

(CONTROL SOURCE/DESTINATION/SENS)

Multi-Effect Control

The SRX WORLD allows you to use control changes and other common MIDI messages to control the most important multi-effect parameters. For example, you might use the pitch bend lever to control the degree of distortion, or use keyboard touch to change the delay time. The parameters that can be controlled in this way are predetermined for each type of multi-effect; such parameters are indicated by a **"#"** in the parameter lists in **"Multi-Effects Parameters (MFX)"** (p. 37).

"Multi-effect control" is the capability of using MIDI messages in this way to control multi-effect parameters in real time. You can specify up to four multi-effect control assignments for the MFX.

In order to use multi-effect control, you'll need to specify which MIDI message (SOURCE) will control which parameter (DESTINATION) by what amount (SENS).

- As a substitute for multi-effect control, you can also use **"MATRIX CONTROL"** (p. 26) to control important multi-effect parameters in real time.

Chorus and Reverb Settings

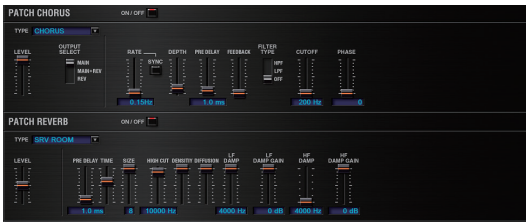

Chorus Settings



Parameter	Range/Explanation
ON/OFF	Turns the chorus on/off
TYPE	Type of chorus OFF: Chorus/delay will not be used CHORUS: Chorus DELAY: Delay GM2 CHORUS: GM2 chorus
LEVEL	Volume of the sound that has been processed by the chorus
OUTPUT SELECT	Output destination of the sound that has been processed by the chorus MAIN: Output in stereo to the OUTPUT MAIN+REV: Output in stereo to the OUTPUT and in mono to the reverb REV: Output in mono to reverb
Parameters for each chorus type	Set the parameters of the selected chorus type. Refer to " Chorus Parameters " (p. 69).

Reverb Settings



Parameter	Range/Explanation
ON/OFF	Turns the reverb on/off * The reverb on/off setting cannot be saved.
TYPE	Type of reverb OFF: Reverb will not be used REVERB: Basic reverb/delay SRV ROOM: Reverb that simulates the reverberation of a room SRV HALL: Reverb that simulates the reverberation of a hall SRV PLATE: Simulation of a plate echo (a reverb device that uses a metal plate) GM2 REVERB: GM2 reverb
LEVEL	Volume of the sound that has been processed by the reverb
Parameters for each reverb type	Set the parameters of the selected reverb type. Refer to " Reverb Parameters " (p. 69).

Effects List

Multi-Effects Parameters (MFX)

The multi-effects feature 78 different kinds of effects. Some of the effects consist of two or more different effects connected in series.

Parameters marked with a sharp “#” can be controlled using a Multi-Effects Control (p. 35) or Matrix Control (p. 26). (Two setting items will change simultaneously for “#1” and “#2.”)

FILTER (10 types)		
01	EQUALIZER	p. 39
02	SPECTRUM	p. 39
03	ISOLATOR	p. 39
04	LOW BOOST	p. 39
05	SUPER FILTER	p. 40
06	STEP FILTER	p. 40
07	ENHANCER	p. 40
08	AUTO WAH	p. 41
09	HUMANIZER	p. 41
10	SPEAKER SIMULATOR	p. 42
MODULATION (12 types)		
11	PHASER	p. 42
12	STEP PHASER	p. 43
13	MULTI STAGE PHASER	p. 43
14	INFINITE PHASER	p. 43
15	RING MODULATOR	p. 44
16	STEP RING MODULATOR	p. 44
17	TREMOLO	p. 44
18	AUTO PAN	p. 45
19	STEP PAN	p. 45
20	SLICER	p. 45
21	ROTARY	p. 46
22	VK ROTARY	p. 46
CHORUS (12 types)		
23	CHORUS	p. 47
24	FLANGER	p. 47
25	STEP FLANGER	p. 48
26	HEXA-CHORUS	p. 48
27	TREMOLO CHORUS	p. 48
28	SPACE-D	p. 49
29	3D CHORUS	p. 49
30	3D FLANGER	p. 50
31	3D STEP FLANGER	p. 50
32	2BAND CHORUS	p. 51
33	2BAND FLANGER	p. 51
34	2BAND STEP FLANGER	p. 52
DYNAMICS (8 types)		
35	OVERDRIVE	p. 52
36	DISTORTION	p. 52
37	VS OVERDRIVE	p. 52
38	VS DISTORTION	p. 53
39	GUITAR AMP SIMULATOR	p. 53
40	COMPRESSOR	p. 53
41	LIMITER	p. 54
42	GATE	p. 54
DELAY (13 types)		
43	DELAY	p. 54
44	LONG DELAY	p. 55
45	SERIAL DELAY	p. 55

46	MODULATION DELAY	p. 56
47	3TAP PAN DELAY	p. 56
48	4TAP PAN DELAY	p. 57
49	MULTI TAP DELAY	p. 57
50	REVERSE DELAY	p. 58
51	SHUFFLE DELAY	p. 58
52	3D DELAY	p. 59
53	TIME CTRL DELAY	p. 59
54	LONG TIME CTRL DELAY	p. 60
55	TAPE ECHO	p. 60
LO-FI (5 types)		
56	LOFI NOISE	p. 61
57	LOFI COMPRESS	p. 61
58	LOFI RADIO	p. 62
59	TELEPHONE	p. 62
60	PHONOGRAPH	p. 62
PITCH (3 types)		
61	PITCH SHIFTER	p. 63
62	2VOICE PITCH SHIFTER	p. 63
63	STEP PITCH SHIFTER	p. 64
REVERB (2 types)		
64	REVERB	p. 64
65	GATED REVERB	p. 65
COMBINATION (12 types)		
66	OVERDRIVE → CHORUS	p. 65
67	OVERDRIVE → FLANGER	p. 65
68	OVERDRIVE → DELAY	p. 65
69	DISTORTION → CHORUS	p. 66
70	DISTORTION → FLANGER	p. 66
71	DISTORTION → DELAY	p. 66
72	ENHANCER → CHORUS	p. 66
73	ENHANCER → FLANGER	p. 66
74	ENHANCER → DELAY	p. 67
75	CHORUS → DELAY	p. 67
76	FLANGER → DELAY	p. 67
77	CHORUS → FLANGER	p. 68
PIANO (1 type)		
78	SYMPATHETIC RESONANCE	p. 68

About RATE and DELAY TIME

Some of the effect parameters can be set in terms of a note value (these are parameters that specify a cycle, such as RATE or DELAY TIME). These parameters have a SYNC switch that lets you choose whether to set them as a numerical frequency or time, or as a note value.

If you want to set RATE (DELAY TIME) as a numerical value, set the SYNC switch to **"OFF."** If you want to set it as a note value, set the SYNC switch to **"ON."**

* If RATE is specified as a note value, the modulation is synchronized to the tempo of the DAW.

	Sixty-fourth-note triplet		Sixty-fourth note		Thirty-second-note triplet		Thirty-second note
	Sixteenth-note triplet		Dotted thirty-second note		Sixteenth note		Eighth-note triplet
	Dotted sixteenth note		Eighth note		Quarter-note triplet		Dotted eighth note
	Quarter note		Half-note triplet		Dotted quarter note		Half note
	Whole-note triplet		Dotted half note		Whole note		Double-note triplet
	Dotted whole note		Double note				

NOTE

- If a parameter whose SYNC switch is set to **"ON"** is specified as a destination for multi-effect control, you will not be able to use multi-effect control to control that parameter.
- If you specify the delay time as a note value, slowing down the tempo will not change the delay time beyond a certain length. This is because there is an upper limit for the delay time; if the delay time is specified as a note value and you slow down the tempo until this upper limit is reached, the delay time cannot change any further. This upper limit is the maximum value that can be specified when setting the delay time as a numerical value.

When Using 3D Effects

The following 3D effects utilize RSS (Roland Sound Space) technology to create a spaciousness that cannot be produced by delay, reverb, chorus, etc.

- 52: 3D DELAY
- 29: 3D CHORUS
- 30: 3D FLANGER
- 31: 3D STEP FLANGER

When using these effects, we recommend that you place the speakers as follows. Also, make sure that the speakers are at a sufficient distance from the walls on either side.

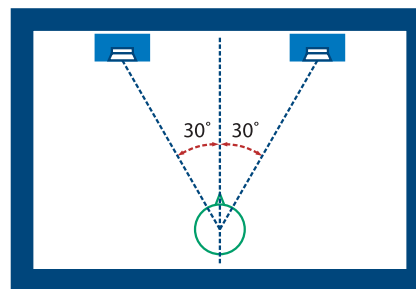

If the left and right speakers are too far apart, or if there is too much reverberation, the full 3D effect may not appear.

Each of these effects has an **"OUTPUT MODE"** parameter. If the sound from the OUTPUT is to be heard through speakers, set this parameter to **"SPEAKER."** If the sound is to be heard through headphones, set it to **"PHONES."** This will ensure that the optimal 3D effect will be heard. If this parameter is not set correctly, the full 3D effect may not appear.

About the STEP RESET function

- 06: STEP FILTER
- 16: STEP RING MODULATOR
- 19: STEP PAN
- 20: SLICER
- 63: STEP PITCH SHIFTER

The above five types contain a sixteen-step sequencer.

For these types, you can use a multi-effect control (p. 35) to reset the sequence to play from the first step.

To do this, set the multi-effect control DESTINATION to **"STEP RESET."**

For example if you are using the modulation lever to control the effect, you would make the following settings.

SOURCE: CC01: MODULATION

DESTINATION: STEP RESET

SENS: 63

With these settings, the sequence will play back from the first step whenever you operate the modulation lever.

01: EQUALIZER

this is a four-band stereo equalizer (low, mid x 2, high).

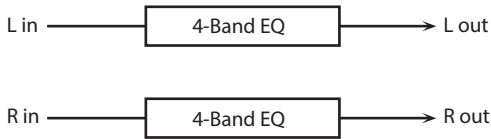

Parameter	Value	Explanation
LOW FREQ	200, 400 Hz	Frequency of the low range
LOW GAIN #	-15~+15 dB	Amount of boost/cut for the low-frequency range
MID1 FREQ	200~8000 Hz	Frequency of the middle range 1
MID1 Q	0.5, 1.0, 2.0, 4.0, 8.0	Width of the middle range 1 Set a higher value for Q to narrow the range to be affected.
MID1 GAIN	-15~+15 dB	Gain of the middle range 1
MID2 FREQ	200~8000 Hz	Frequency of the middle range 2
MID2 Q	0.5, 1.0, 2.0, 4.0, 8.0	Width of the middle range 2 Set a higher value for Q to narrow the range to be affected.
MID2 GAIN	-15~+15 dB	Gain of the middle range 2
HIGH FREQ	2000, 4000, 8000 Hz	Frequency of the high range
HIGH GAIN #	-15~+15 dB	Amount of boost/cut for the high-frequency range
OUTPUT LEVEL #	0~127	Output Level

02: SPECTRUM

This is a stereo spectrum. Spectrum is a type of filter which modifies the timbre by boosting or cutting the level at specific frequencies.

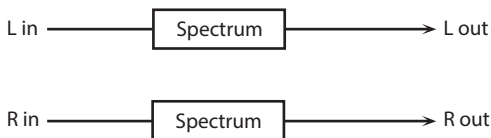

Parameter	Value	Explanation
250Hz	-15~+15 dB	Gain of each frequency band
500Hz		
1000Hz		
1250Hz		
2000Hz		
3150Hz		
4000Hz		
8000Hz		
BAND WIDTH	0.5, 1.0, 2.0, 4.0, 8.0	Simultaneously adjusts the width of the adjusted ranges for all the frequency bands.
OUTPUT LEVEL #	0~127	Output Level

03: ISOLATOR

This is an equalizer which cuts the volume greatly, allowing you to add a special effect to the sound by cutting the volume in varying ranges.

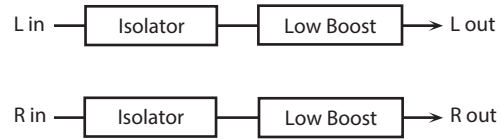

Parameter	Value	Explanation
BOOST/CUT LOW #	-60~+4 dB	These boost and cut each of the High, Middle, and Low frequency ranges. At -60 dB, the sound becomes inaudible. 0 dB is equivalent to the input level of the sound.
BOOST/CUT MID #		
BOOST/CUT HIGH #		
ANTI PHASE LOW SW	OFF, ON	Turns the Anti-Phase function on and off for the Low frequency ranges. When turned on, the counter-channel of stereo sound is inverted and added to the signal.
ANTI PHASE LOW LEVEL	0~127	Adjusts the Anti-Phase Level settings for the Low frequency ranges. Adjusting this level for certain frequencies allows you to lend emphasis to specific parts. (This is effective only for stereo source.)
ANTI PHASE MID SW	OFF, ON	Settings of the Anti-Phase function for the Middle frequency ranges The parameters are the same as for the Low frequency ranges.
ANTI PHASE MID LEVEL	0~127	
LOW BOOST SW	OFF, ON	Turns Low Booster on/off. This emphasizes the bottom to create a heavy bass sound.
LOW BOOST LEVEL	0~127	Increasing this value gives you a heavier low end. * Depending on the Isolator and filter settings this effect may be hard to distinguish.
OUTPUT LEVEL	0~127	Output Level

04: LOW BOOST

Boosts the volume of the lower range, creating powerful lows.

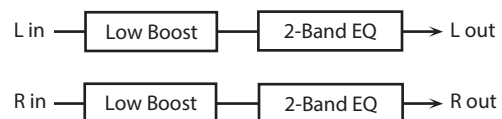

Parameter	Value	Explanation
BOOST FREQUENCY #	50~125 Hz	Center frequency at which the lower range will be boosted
BOOST GAIN #	0~+12 dB	Amount by which the lower range will be boosted
BOOST WIDTH	WIDE, MID, NARROW	Width of the lower range that will be boosted
EQ GAIN LOW	-15~+15 dB	Gain of the low frequency range
EQ GAIN HIGH	-15~+15 dB	Gain of the high frequency range
OUTPUT LEVEL	0~127	Output level

05: SUPER FILTER

This is a filter with an extremely sharp slope. The cutoff frequency can be varied cyclically.

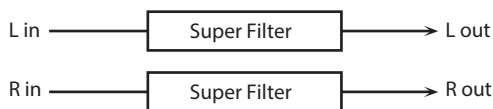

Parameter	Value	Explanation
FILTER TYPE	LPF, BPF, HPF, NOTCH	Filter type Frequency range that will pass through each filter LPF : frequencies below the cutoff BPF : frequencies in the region of the cutoff HPF : frequencies above the cutoff NOTCH : frequencies other than the region of the cutoff
FILTER SLOPE	-12, -24, -36 dB	Amount of attenuation per octave -36 dB : extremely steep -24 dB : steep -12 dB : gentle
FILTER CUTOFF #	0-127	Cutoff frequency of the filter Increasing this value will raise the cutoff frequency.
FILTER RESONANCE #	0-127	Filter resonance level Increasing this value will emphasize the region near the cutoff frequency.
FILTER GAIN	0-+12 dB	Amount of boost for the filter output
MODULATION SW	OFF, ON	Turns on/off cyclic change of the cutoff frequency
MODULATION WAVE	TRI, SQR, SIN, SAW1, SAW2 SAW1 SAW2	How the cutoff frequency will be modulated TRI : triangle wave SQR : square wave SIN : sine wave SAW1 : sawtooth wave (upward) SAW2 : sawtooth wave (downward)
RATE #	0.05-10.00 Hz, note	Rate of modulation
DEPTH	0-127	Depth of modulation
ATTACK #	0-127	Speed at which the cutoff frequency will change This is effective if Modulation Wave is SQR, SAW1, or SAW2.
OUTPUT LEVEL	0-127	Output Level

06: STEP FILTER

This is a filter whose cutoff frequency can be modulated in steps. You can specify the pattern by which the cutoff frequency will change.

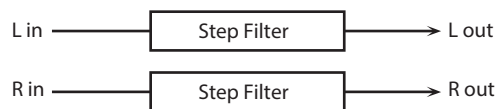

Parameter	Value	Explanation
RATE #	0.05-10.00 Hz, note	Rate of modulation
ATTACK #	0-127	Speed at which the cutoff frequency changes between steps
FILTER TYPE	LPF, BPF, HPF, NOTCH	Filter type Frequency range that will pass through each filter LPF : frequencies below the cutoff BPF : frequencies in the region of the cutoff HPF : frequencies above the cutoff NOTCH : frequencies other than the region of the cutoff
FILTER SLOPE	-12, -24, -36 dB	Amount of attenuation per octave -12 dB : gentle -24 dB : steep -36 dB : extremely steep
FILTER RESONANCE #	0-127	Filter resonance level Increasing this value will emphasize the region near the cutoff frequency.
FILTER GAIN	0-+12 dB	Amount of boost for the filter output
OUTPUT LEVEL	0-127-	Output level
STEP 1-16	0-127	Cutoff frequency at each step

MEMO

You can use multi-effect control to make the step sequence play again from the beginning (p. 38).

07: ENHANCER

Controls the overtone structure of the high frequencies, adding sparkle and tightness to the sound.

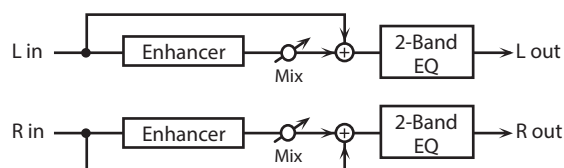

Parameter	Value	Explanation
SENS #	0-127	Sensitivity of the enhancer
MIX #	0-127	Level of the overtones generated by the enhancer
EQ GAIN LOW	-15-+15 dB	Amount of boost/cut for the low-frequency range
EQ GAIN HIGH	-15-+15 dB	Amount of boost/cut for the high-frequency range
OUTPUT LEVEL	0-127	Output Level

08: AUTO WAH

Cyclically controls a filter to create cyclic change in timbre.

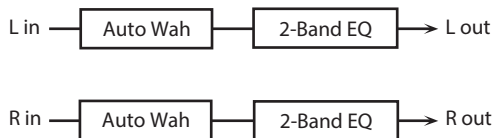

Parameter	Value	Explanation
FILTER TYPE	LPF, BPF	Type of filter LPF: The wah effect will be applied over a wide frequency range. BPF: The wah effect will be applied over a narrow frequency range.
SENS #	0-127	Adjusts the sensitivity with which the filter is controlled.
MANUAL #	0-127	Adjusts the center frequency at which the effect is applied.
PEAK	0-127	Adjusts the amount of the wah effect that will occur in the range of the center frequency. Set a higher value for Q to narrow the range to be affected.
RATE #	0.05-10.00 Hz, note	Frequency of modulation
SYNC	OFF, ON	If this is on, the RATE setting will be a note value.
DEPTH #	0-127	Depth of modulation
POLARITY	UP, DOWN	Sets the direction in which the frequency will change when the auto-wah filter is modulated. UP: The filter will change toward a higher frequency. DOWN: The filter will change toward a lower frequency.
PHASE #	0-180 deg	Adjusts the degree of phase shift of the left and right sounds when the wah effect is applied.
EQ GAIN LOW	-15-+15 dB	Amount of boost/cut for the low-frequency range
EQ GAIN HIGH	-15-+15 dB	Amount of boost/cut for the high-frequency range
OUTPUT LEVEL	0-127	Output Level

09: HUMANIZER

Adds a vowel character to the sound, making it similar to a human voice.

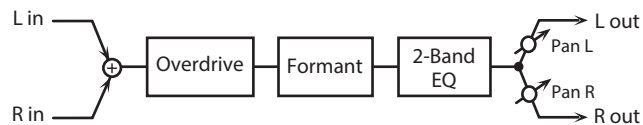

Parameter	Value	Explanation
OVERDRIVE SW	OFF, ON	Turns Drive on/off.
DRIVE #	0-127	Degree of distortion Also changes the volume.
VOWEL1	a, e, i, o, u	Selects the vowel.
VOWEL2	a, e, i, o, u	
RATE #	0.05-10.00 Hz, note	Frequency at which the two vowels switch
DEPTH #	0-127	Effect depth
MANUAL #	0-100	Point at which Vowel 1/2 switch 49 or less: Vowel 1 will have a longer duration. 50: Vowel 1 and 2 will be of equal duration. 51 or more: Vowel 2 will have a longer duration.
INPUT SYNC SW	OFF, ON	LFO reset on/off Determines whether the LFO for switching the vowels is reset by the input signal (ON) or not (OFF).
INPUT SYNC THRESHOLD	0-127	Volume level at which reset is applied
EQ GAIN LOW	-15-+15 dB	Gain of the low frequency range
EQ GAIN HIGH	-15-+15 dB	Gain of the high frequency range
OUTPUT LEVEL	0-127	Output Level
OUTPUT PAN #	L64-63R	Stereo location of the output sound

10: SPEAKER SIMULATOR

Simulates the speaker type and microphone settings used to record the speaker sound.

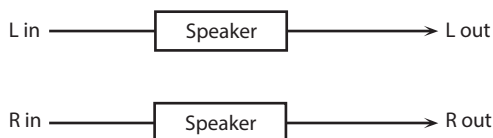

Parameter	Value	Explanation
SPEAKER TYPE	(See the table right.)	Type of speaker
MIC SETTING	1, 2, 3	Adjusts the location of the microphone that is recording the sound of the speaker. This can be adjusted in three steps, with the microphone becoming more distant in the order of 1, 2, and 3.
MIC LEVEL #	0-127	Volume of the microphone
DIRECT LEVEL #	0-127	Volume of the direct sound
OUTPUT LEVEL #	0-127	Output Level

Specifications of each Speaker Type

The speaker column indicates the diameter of each speaker unit (in inches) and the number of units.

Type	Cabinet	Speaker	Microphone
SMALL 1	small open-back enclosure	10	dynamic
SMALL 2	small open-back enclosure	10	dynamic
MIDDLE	open back enclosure	12 x 1	dynamic
JC-120	open back enclosure	12 x 2	dynamic
BUILT-IN 1	open back enclosure	12 x 2	dynamic
BUILT-IN 2	open back enclosure	12 x 2	condenser
BUILT-IN 3	open back enclosure	12 x 2	condenser
BUILT-IN 4	open back enclosure	12 x 2	condenser
BUILT-IN 5	open back enclosure	12 x 2	condenser
BG STACK 1	sealed enclosure	12 x 2	condenser
BG STACK 2	large sealed enclosure	12 x 2	condenser
MS STACK 1	large sealed enclosure	12 x 4	condenser
MS STACK 2	large sealed enclosure	12 x 4	condenser
METAL STACK	large double stack	12 x 4	condenser
2-STACK	large double stack	12 x 4	condenser
3-STACK	large triple stack	12 x 4	condenser

11: PHASER

A phase-shifted sound is added to the original sound and modulated.

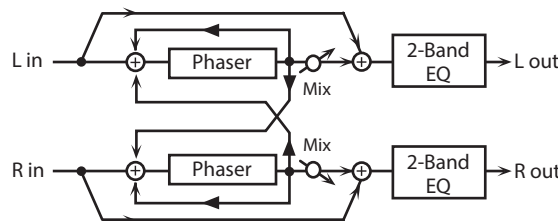

Parameter	Value	Explanation
MODE	4-STAGE, 8-STAGE, 12-STAGE	Number of stages in the phaser
POLARITY	INVERSE, SYNCHRO	Selects whether the left and right phase of the modulation will be the same or the opposite. INVERSE: The left and right phase will be opposite. When using a mono source, this spreads the sound. SYNCHRO: The left and right phase will be the same. Select this when inputting a stereo source.
MANUAL #	0-127	Adjusts the basic frequency from which the sound will be modulated.
RATE #	0.05-10.00 Hz, note	Frequency of modulation
DEPTH	0-127	Depth of modulation
RESONANCE #	0-127	Amount of feedback
X-FEEDBACK	-98-+98 %	Adjusts the proportion of the phaser sound that is fed back into the effect. Negative (-) settings will invert the phase.
MIX LEVEL #	0-127	Level of the phase-shifted sound
EQ GAIN LOW	-15-+15 dB	Amount of boost/cut for the low-frequency range
EQ GAIN HIGH	-15-+15 dB	Amount of boost/cut for the high-frequency range
OUTPUT LEVEL	0-127	Output Level

12: STEP PHASER

The phaser effect will be varied step by step.

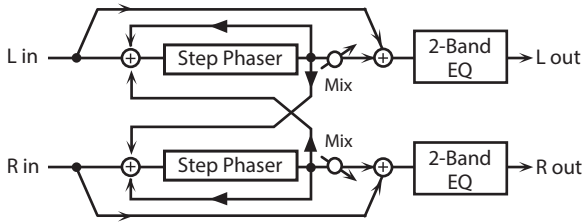

Parameter	Value	Explanation
MODE	4-STAGE, 8-STAGE, 12-STAGE	Number of stages in the phaser
POLARITY	INVERSE, SYNCHRO	Selects whether the left and right phase of the modulation will be the same or the opposite. INVERSE: The left and right phase will be opposite. When using a mono source, this spreads the sound. SYNCHRO: The left and right phase will be the same. Select this when inputting a stereo source.
MANUAL #	0-127	Adjusts the basic frequency from which the sound will be modulated.
RATE #	0.05-10.00 Hz, note	Frequency of modulation
DEPTH	0-127	Depth of modulation
RESONANCE #	0-127	Amount of feedback
X-FEEDBACK	-98-+98 %	Adjusts the proportion of the phaser sound that is fed back into the effect. Negative (-) settings will invert the phase.
STEP RATE #	0.10-20.00 Hz, note	Rate of the step-wise change in the phaser effect
MIX LEVEL #	0-127	Level of the phase-shifted sound
EQ GAIN LOW	-15-+15 dB	Amount of boost/cut for the low-frequency range
EQ GAIN HIGH	-15-+15 dB	Amount of boost/cut for the high-frequency range
OUTPUT LEVEL	0-127	Output Level

13: MULTI STAGE PHASER

Extremely high settings of the phase difference produce a deep phaser effect.

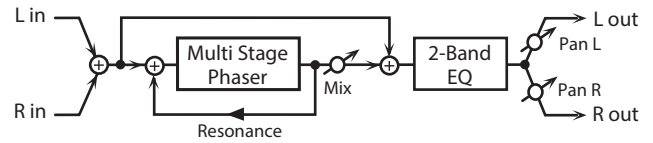

Parameter	Value	Explanation
MODE	4-STAGE, 8-STAGE, 12-STAGE, 16-STAGE, 20-STAGE, 24-STAGE	Number of stages in the phaser
MANUAL #	0-127	Adjusts the basic frequency from which the sound will be modulated.
RATE #	0.05-10.00 Hz, note	Frequency of modulation
DEPTH	0-127	Depth of modulation
RESONANCE #	0-127	Amount of feedback
MIX LEVEL #	0-127	Level of the phase-shifted sound
EQ GAIN LOW	-15-+15 dB	Amount of boost/cut for the low-frequency range
EQ GAIN HIGH	-15-+15 dB	Amount of boost/cut for the high-frequency range
OUTPUT LEVEL	0-127	Output Level
OUTPUT PAN #	L64-63R	Stereo location of the output sound

14: INFINITE PHASER

A phaser that continues raising/lowering the frequency at which the sound is modulated.

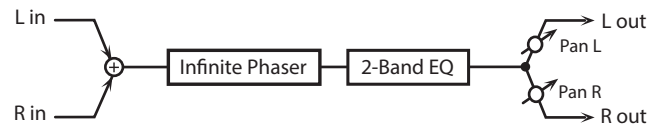

Parameter	Value	Explanation
MODE	1, 2, 3, 4	Higher values will produce a deeper phaser effect.
SPEED #	-100-+100	Speed at which to raise or lower the frequency at which the sound is modulated (+: upward / -: downward)
RESONANCE #	0-127	Amount of feedback
MIX LEVEL #	0-127	Level of the phase-shifted sound
EQ GAIN LOW	-15-+15 dB	Amount of boost/cut for the low-frequency range
EQ GAIN HIGH	-15-+15 dB	Amount of boost/cut for the high-frequency range
OUTPUT LEVEL	0-127	Output Level
OUTPUT PAN #	L64-63R	Stereo location of the output sound

15: RING MODULATOR

This is an effect that applies amplitude modulation (AM) to the input signal, producing bell-like sounds. You can also change the modulation frequency in response to changes in the volume of the sound sent into the effect.

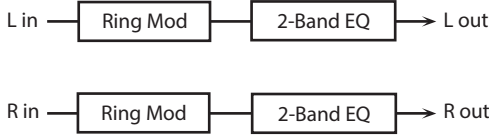

Parameter	Value	Explanation
FREQUENCY #	0-127	Adjusts the frequency at which modulation is applied.
SENS #	0-127	Adjusts the amount of frequency modulation applied.
POLARITY	UP, DOWN	Direction in which the frequency is moved UP: Toward a higher frequency DOWN: Toward a lower frequency
EQ GAIN LOW	-15-+15 dB	Amount of boost/cut for the low-frequency range
EQ GAIN HIGH	-15-+15 dB	Amount of boost/cut for the high-frequency range
BALANCE #	D100:0W-D0:100W	Volume balance between the direct sound (D) and the effect sound (W)
OUTPUT LEVEL	0-127	Output Level

16: STEP RING MODULATOR

This is a ring modulator that uses a 16-step sequence to vary the frequency at which modulation is applied.

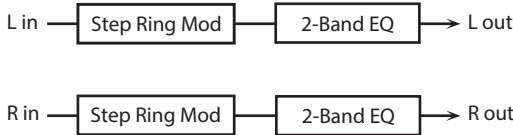

Parameter	Value	Explanation
RATE #	0.05-10.00 Hz, note	Rate at which the 16-step sequence will cycle
ATTACK #	0-127	Speed at which the modulation frequency changes between steps
EQ GAIN LOW	-15-+15 dB	Amount of boost/cut for the low-frequency range
EQ GAIN HIGH	-15-+15 dB	Amount of boost/cut for the high-frequency range
BALANCE #	D100:0W-D0:100W	Volume balance of the original sound (D) and effect sound (W)
OUTPUT LEVEL	0-127	Output Level
STEP 1-16	0-127	Frequency of ring modulation at each step

MEMO

You can use multi-effect control to make the step sequence play again from the beginning (p. 38).

17: TREMOLO

Cyclically modulates the volume to add tremolo effect to the sound.

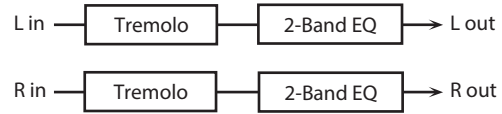

Parameter	Value	Explanation
MOD WAVE	TRI, SQR, SIN, SAW1, SAW2	Modulation Wave TRI: Triangle wave SQR: Square wave SIN: Sine wave SAW1/2: Sawtooth wave
	SAW1 SAW2	
RATE #	0.05-10.00 Hz, note	Frequency of the change
DEPTH #	0-127	Depth to which the effect is applied
EQ GAIN LOW	-15-+15 dB	Amount of boost/cut for the low-frequency range
EQ GAIN HIGH	-15-+15 dB	Amount of boost/cut for the high-frequency range
OUTPUT LEVEL	0-127	Output Level

18: AUTO PAN

Cyclically modulates the stereo location of the sound.

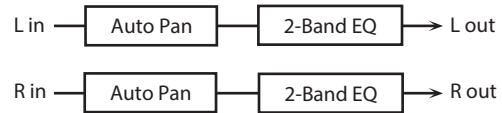

Parameter	Value	Explanation
MOD WAVE	TRI, SQR, SIN, SAW1, SAW2	Modulation Wave TRI: Triangle wave SQR: Square wave SIN: Sine wave SAW1/2: Sawtooth wave
	SAW1 R SAW2 R	
RATE #	0.05-10.00 Hz, note	Frequency of the change
DEPTH #	0-127	Depth to which the effect is applied
EQ GAIN LOW	-15-+15 dB	Amount of boost/cut for the low-frequency range
EQ GAIN HIGH	-15-+15 dB	Amount of boost/cut for the high-frequency range
OUTPUT LEVEL	0-127	Output Level

19: STEP PAN

This uses a 16-step sequence to vary the panning of the sound.

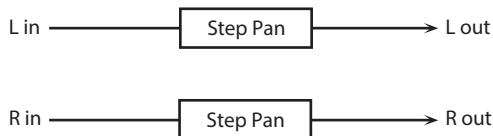

Parameter	Value	Explanation
RATE #	0.05–10.00 Hz, note	Rate at which the 16-step sequence will cycle
ATTACK #	0–127	Speed at which the pan changes between steps
INPUT SYNC SW	OFF, ON	Specifies whether an input note will cause the sequence to resume from the first step of the sequence (ON) or not (OFF)
INPUT SYNC THRESHOLD	0–127	Volume at which an input note will be detected
OUTPUT LEVEL	0–127	Output Level
STEP 1–16	L64–63R	Pan at each step

MEMO

You can use multi-effect control to make the step sequence play again from the beginning (p. 38).

20: SLICER

By applying successive cuts to the sound, this effect turns a conventional sound into a sound that appears to be played as a backing phrase. This is especially effective when applied to sustain-type sounds.

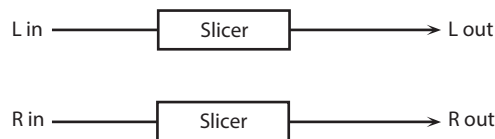

Parameter	Value	Explanation
RATE #	0.05–10.00 Hz, note	Rate at which the 16-step sequence will cycle
ATTACK #	0–127	Speed at which the level changes between steps
MODE	LEGATO, SLASH	Sets the manner in which the volume changes as one step progresses to the next. LEGATO: The change in volume from one step's level to the next remains unaltered. If the level of a following step is the same as the one preceding it, there is no change in volume. SLASH: The level is momentarily set to 0 before progressing to the level of the next step. This change in volume occurs even if the level of the following step is the same as the preceding step.
SHUFFLE #	0–127	Timing when to shift to even-numbered steps (step 2, step 4, step 6...). The higher the value, the later the beat progresses.
INPUT SYNC SW	OFF, ON	Specifies whether an input note will cause the sequence to resume from the first step of the sequence (ON) or not (OFF)
INPUT SYNC THRESHOLD	0–127	Volume at which an input note will be detected
OUTPUT LEVEL	0–127	Output Level
STEP 1–16	0–127	Level at each step

MEMO

You can use multi-effect control to make the step sequence play again from the beginning (p. 38).

21: ROTARY

This simulates a classic rotary speaker of the past.

Since the operation of the high-frequency and low-frequency rotors can be specified independently, the distinctive modulation can be reproduced realistically. This is most effective on organ patches.

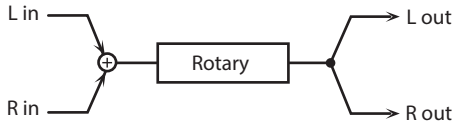

Parameter	Value	Explanation
SPEED #	SLOW, FAST	Simultaneously switch the rotational speed of the low frequency rotor and high frequency rotor. SLOW: Slows down the rotation to the Slow Rate. FAST: Speeds up the rotation to the Fast Rate.
WOOFER SLOW	0.05–10.00 Hz	Slow speed (SLOW) of the low frequency rotor
WOOFER FAST	0.05–10.00 Hz	Fast speed (FAST) of the low frequency rotor
WOOFER ACCEL	0–15	Adjusts the time it takes the low frequency rotor to reach the newly selected speed when switching from fast to slow (or slow to fast) speed. Lower values will require longer times.
WOOFER LEVEL	0–127	Volume of the low frequency rotor
TWEETER SLOW	0.05–10.00 Hz	Settings of the high frequency rotor The parameters are the same as for the low frequency rotor
TWEETER FAST	0.05–10.00 Hz	
TWEETER ACCEL	0–15	
TWEETER LEVEL	0–127	
SEPARATION	0–127	Spatial dispersion of the sound
OUTPUT LEVEL #	0–127	Output Level

22: VK ROTARY

This type provides modified response for the rotary speaker, with the low end boosted further.

This effect features the same specifications as the VK-7's built-in rotary speaker.

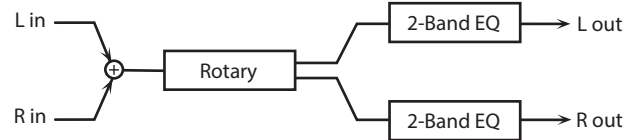

Parameter	Value	Explanation
SPEED #	SLOW, FAST	Rotational speed of the rotating speaker SLOW: Slows down the rotation to the Slow Rate. FAST: Speeds up the rotation to the Fast Rate.
BRAKE #	OFF, ON	Switches the rotation of the rotary speaker. When this is turned on, the rotation will gradually stop. When it is turned off, the rotation will gradually resume.
WOOFER SLOW	0.05–10.00 Hz	Low-speed rotation speed of the woofer
WOOFER FAST	0.05–10.00 Hz	High-speed rotation speed of the woofer
WOOFER TRANS UP	0–127	Adjusts the rate at which the woofer rotation speeds up when the rotation is switched from Slow to Fast.
WOOFER TRANS DOWN	0–127	Adjusts the rate at which the woofer rotation speeds up when the rotation is switched from Fast to Slow.
WOOFER LEVEL	0–127	Volume of the woofer
TWEETER SLOW	0.05–10.00 Hz	Settings of the tweeter The parameters are the same as for the woofer.
TWEETER FAST	0.05–10.00 Hz	
TWEETER TRANS UP	0–127	
TWEETER TRANS DOWN	0–127	
TWEETER LEVEL	0–127	
SPREAD	0–10	Sets the rotary speaker stereo image. The higher the value set, the wider the sound is spread out.
EQ GAIN LOW	-15–+15 dB	Amount of boost/cut for the low-frequency range
EQ GAIN HIGH	-15–+15 dB	Amount of boost/cut for the high-frequency range
OUTPUT LEVEL #	0–127	Output Level

23: CHORUS

This is a stereo chorus. A filter is provided so that you can adjust the timbre of the chorus sound.

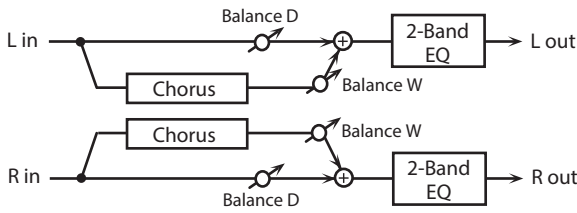

Parameter	Value	Explanation
CHORUS RATE #	0.05–10.00 Hz, note	Frequency of modulation
CHORUS DEPTH	0–127	Depth of modulation
CHORUS PHASE	0–180 deg	Spatial spread of the sound
CHORUS PRE DELAY	0.0–100 msec	Adjusts the delay time from the direct sound until the chorus sound is heard.
FILTER TYPE	OFF, LPF, HPF	Type of filter OFF : no filter is used LPF : cuts the frequency range above the Cutoff Freq HPF : cuts the frequency range below the Cutoff Freq
FILTER CUTOFF	200–8000 Hz	Center frequency when using the filter to cut a specific frequency range
EQ GAIN LOW	-15–+15 dB	Amount of boost/cut for the low-frequency range
EQ GAIN HIGH	-15–+15 dB	Amount of boost/cut for the high-frequency range
BALANCE #	D100:0W–D0:100W	Volume balance between the direct sound (D) and the chorus sound (W)
OUTPUT LEVEL	0–127	Output Level

24: FLANGER

This is a stereo flanger. (The LFO has the same phase for left and right.) It produces a metallic resonance that rises and falls like a jet airplane taking off or landing. A filter is provided so that you can adjust the timbre of the flanged sound.

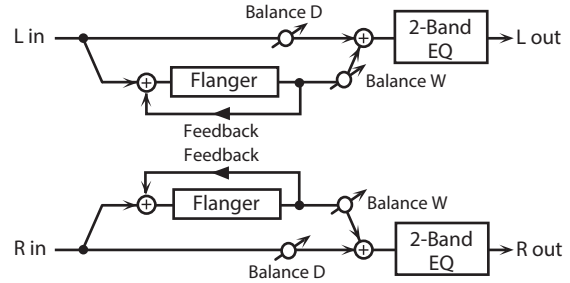

Parameter	Value	Explanation
FLANGER RATE #	0.05–10.00 Hz, note	Frequency of modulation
FLANGER DEPTH	0–127	Depth of modulation
FLANGER FEEDBACK #	-98–+98 %	Adjusts the proportion of the flanger sound that is fed back into the effect. Negative (-) settings will invert the phase.
FLANGER PHASE	0–180 deg	Spatial spread of the sound
FLANGER PRE DELAY	0.0–100 msec	Adjusts the delay time from when the direct sound begins until the flanger sound is heard.
FILTER TYPE	OFF, LPF, HPF	Type of filter OFF : no filter is used LPF : cuts the frequency range above the Cutoff Freq HPF : cuts the frequency range below the Cutoff Freq
FILTER CUTOFF	200–8000 Hz	Center frequency when using the filter to cut a specific frequency range
EQ GAIN LOW	-15–+15 dB	Amount of boost/cut for the low-frequency range
EQ GAIN HIGH	-15–+15 dB	Amount of boost/cut for the high-frequency range
BALANCE #	D100:0W–D0:100W	Volume balance between the direct sound (D) and the flanger sound (W)
OUTPUT LEVEL	0–127	Output Level

25: STEP FLANGER

This is a flanger in which the flanger pitch changes in steps. The speed at which the pitch changes can also be specified in terms of a note-value of a specified tempo.

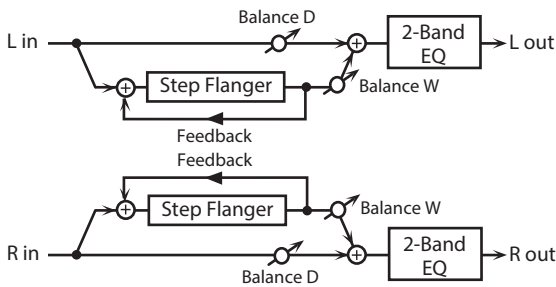

Parameter	Value	Explanation
FLANGER RATE #	0.05–10.00 Hz, note	Frequency of modulation
FLANGER DEPTH	0–127	Depth of modulation
FLANGER FEEDBACK #	-98–+98 %	Adjusts the proportion of the flanger sound that is fed back into the effect. Negative (-) settings will invert the phase.
FLANGER PHASE	0–180 deg	Spatial spread of the sound
FLANGER PRE DELAY	0.0–100 msec	Adjusts the delay time from when the direct sound begins until the flanger sound is heard.
FILTER TYPE	OFF, LPF, HPF	Type of filter OFF : no filter is used LPF : cuts the frequency range above the Cutoff Freq HPF : cuts the frequency range below the Cutoff Freq
FILTER CUTOFF	200–8000 Hz	Center frequency when using the filter to cut a specific frequency range
STEP RATE #	0.10–20.00 Hz, note	Rate (period) of pitch change
EQ GAIN LOW	-15–+15 dB	Amount of boost/cut for the low-frequency range
EQ GAIN HIGH	-15–+15 dB	Amount of boost/cut for the high-frequency range
BALANCE #	D100:0W–D0:100W	Volume balance between the direct sound (D) and the flanger sound (W)
OUTPUT LEVEL	0–127	Output Level

26: HEXA-CHORUS

Uses a six-phase chorus (six layers of chorused sound) to give richness and spatial spread to the sound.

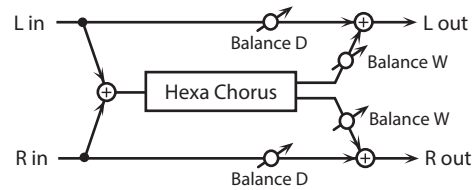

Parameter	Value	Explanation
RATE #	0.05–10.00 Hz, note	Frequency of modulation
DEPTH	0–127	Depth of modulation
DEPTH DEVIATION	-20–+20	Adjusts the difference in modulation depth between each chorus sound.
PRE DELAY	0.0–100 msec	Adjusts the delay time from the direct sound until the chorus sound is heard.
DELAY DEVIATION	0–20	Adjusts the differences in Pre Delay between each chorus sound.
PAN DEVIATION	0–20	Adjusts the difference in stereo location between each chorus sound. 0 : All chorus sounds will be in the center. 20 : Each chorus sound will be spaced at 60 degree intervals relative to the center.
BALANCE #	D100:0W–D0:100W	Volume balance between the direct sound (D) and the chorus sound (W)
OUTPUT LEVEL	0–127	Output Level

27: TREMOLO CHORUS

This is a chorus effect with added Tremolo (cyclic modulation of volume).

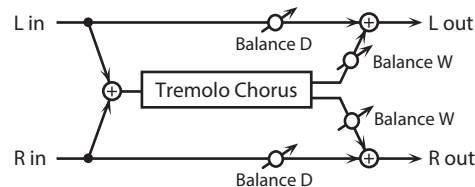

Parameter	Value	Explanation
CHORUS RATE #	0.05–10.00 Hz, note	Modulation frequency of the chorus effect
CHORUS DEPTH	0–127	Modulation depth of the chorus effect
CHORUS PRE DELAY	0.0–100 msec	Adjusts the delay time from the direct sound until the chorus sound is heard.
TREMOLO RATE #	0.05–10.00 Hz, note	Adjusts the modulation speed of the tremolo effect.
TREMOLO PHASE	0–180 deg	Adjusts the width of the tremolo sound.
TREMOLO SEPARATION	0–127	Adjusts the spatial spread of the tremolo effect.
BALANCE #	D100:0W–D0:100W	Volume balance between the direct sound (D) and the tremolo chorus sound (W)
OUTPUT LEVEL	0–127	Output Level

28: SPACE-D

This is a multiple chorus that applies two-phase modulation in stereo. It gives no impression of modulation, but produces a transparent chorus effect.

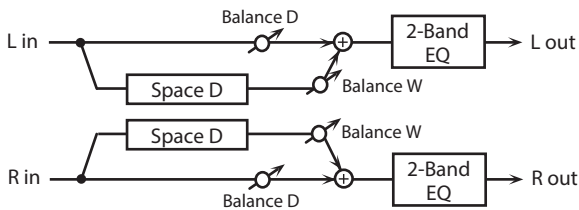

Parameter	Value	Explanation
RATE #	0.05–10.00 Hz, note	Frequency of modulation
DEPTH	0–127	Depth of modulation
PHASE	0–180 deg	Spatial spread of the sound
PRE DELAY	0.0–100 msec	Adjusts the delay time from the direct sound until the chorus sound is heard.
EQ GAIN LOW	-15–+15 dB	Amount of boost/cut for the low-frequency range
EQ GAIN HIGH	-15–+15 dB	Amount of boost/cut for the high-frequency range
BALANCE #	D100:0W–D0:100W	Volume balance between the direct sound (D) and the chorus sound (W)
OUTPUT LEVEL	0–127	Output Level

29: 3D CHORUS

This applies a 3D effect to the chorus sound. The chorus sound will be positioned 90 degrees left and 90 degrees right.

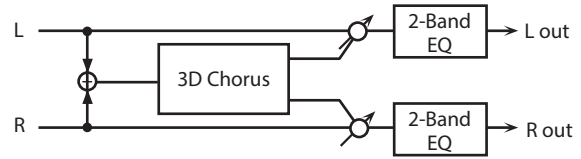

Parameter	Value	Explanation
RATE #	0.05–10.00 Hz, note	Modulation frequency of the chorus effect
DEPTH	0–127	Modulation depth of the chorus effect
PHASE	0–180 deg	Spatial spread of the sound
PRE DELAY	0.0–100 msec	Adjusts the delay time from the direct sound until the chorus sound is heard.
FILTER TYPE	OFF, LPF, HPF	Type of filter OFF: no filter is used LPF: cuts the frequency range above the Cutoff Freq HPF: cuts the frequency range below the Cutoff Freq
CUTOFF	200–8000 Hz	Center frequency when using the filter to cut a specific frequency range
EQ GAIN LOW	-15–+15 dB	Amount of boost/cut for the low-frequency range
EQ GAIN HIGH	-15–+15 dB	Amount of boost/cut for the high-frequency range
BALANCE #	D100:0W–D0:100W	Volume balance between the direct sound (D) and the chorus sound (W)
OUTPUT MODE	SPEAKER, PHONES	Adjusts the method that will be used to hear the sound that is output to the OUTPUT. The optimal 3D effect will be achieved if you select SPEAKER when using speakers, or PHONES when using headphones.
OUTPUT LEVEL	0–127	Output Level

30: 3D FLANGER

This applies a 3D effect to the flanger sound. The flanger sound will be positioned 90 degrees left and 90 degrees right.

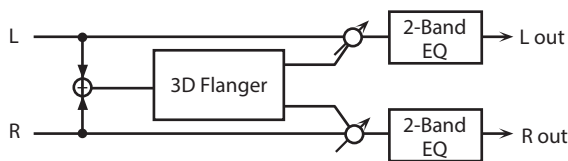

Parameter	Value	Explanation
RATE #	0.05–10.00 Hz, note	Modulation frequency of the flanger effect
DEPTH	0–127	Modulation depth of the flanger effect
FEEDBACK #	-98–+98 %	Adjusts the proportion of the flanger sound that is fed back into the effect. Negative (-) settings will invert the phase.
PHASE	0–180 deg	Spatial spread of the sound
PRE DELAY	0.0–100 msec	Adjusts the delay time from when the direct sound begins until the flanger sound is heard.
FILTER TYPE	OFF, LPF, HPF	Type of filter OFF : no filter is used LPF : cuts the frequency range above the Cutoff Freq HPF : cuts the frequency range below the Cutoff Freq
CUTOFF	200–8000 Hz	Center frequency when using the filter to cut a specific frequency range
EQ GAIN LOW	-15–+15 dB	Amount of boost/cut for the low-frequency range
EQ GAIN HIGH	-15–+15 dB	Amount of boost/cut for the high-frequency range
BALANCE #	D100:0W–D0:100W	Volume balance between the direct sound (D) and the flanger sound (W)
OUTPUT MODE	SPEAKER, PHONES	Adjusts the method that will be used to hear the sound that is output to the OUTPUT. The optimal 3D effect will be achieved if you select SPEAKER when using speakers, or PHONES when using headphones.
OUTPUT LEVEL	0–127	Output Level

31: 3D STEP FLANGER

This applies a 3D effect to the step flanger sound. The flanger sound will be positioned 90 degrees left and 90 degrees right.

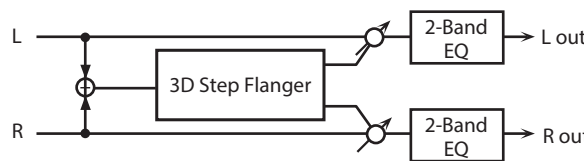

Parameter	Value	Explanation
RATE #	0.05–10.00 Hz, note	Modulation frequency of the flanger effect
DEPTH	0–127	Modulation depth of the flanger effect
FEEDBACK #	-98–+98 %	Adjusts the proportion of the flanger sound that is fed back into the effect. Negative (-) settings will invert the phase.
PHASE	0–180 deg	Spatial spread of the sound
PRE DELAY	0.0–100 msec	Adjusts the delay time from when the direct sound begins until the flanger sound is heard.
FILTER TYPE	OFF, LPF, HPF	Type of filter OFF : no filter is used LPF : cuts the frequency range above the Cutoff Freq HPF : cuts the frequency range below the Cutoff Freq
CUTOFF	200–8000 Hz	Center frequency when using the filter to cut a specific frequency range
STEP RATE #	0.10–20.00 Hz, note	Rate (period) of pitch change
OUTPUT MODE	SPEAKER, PHONES	Adjusts the method that will be used to hear the sound that is output to the OUTPUT. The optimal 3D effect will be achieved if you select SPEAKER when using speakers, or PHONES when using headphones.
EQ GAIN LOW	-15–+15 dB	Amount of boost/cut for the low-frequency range
EQ GAIN HIGH	-15–+15 dB	Amount of boost/cut for the high-frequency range
BALANCE #	D100:0W–D0:100W	Volume balance between the direct sound (D) and the flanger sound (W)
OUTPUT LEVEL	0–127	Output Level

32: 2 BAND CHORUS

A chorus effect that lets you apply an effect independently to the low-frequency and high-frequency ranges.

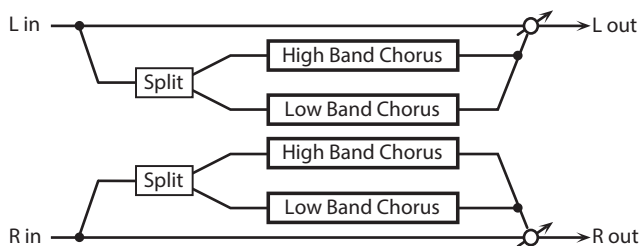

Parameter	Value	Explanation
LOW RATE #	0.05–10.00 Hz, note	Rate at which the low-range chorus sound is modulated
LOW DEPTH	0–127	Modulation depth for the low-range chorus sound
LOW PHASE	0–180 deg	Spaciousness of the low-range chorus sound
LOW PRE DELAY	0.0–100 msec	Delay time from when the original sound is heard to when the low-range chorus sound is heard
HIGH RATE #	0.05–10.00 Hz, note	Rate at which the high-range chorus sound is modulated
HIGH DEPTH	0–127	Modulation depth for the high-range chorus sound
HIGH PHASE	0–180 deg	Spaciousness of the high-range chorus sound
HIGH PRE DELAY	0.0–100 msec	Delay time from when the original sound is heard to when the high-range chorus sound is heard
SPLIT FREQUENCY	200–8000 Hz	Frequency at which the low and high ranges will be divided
BALANCE #	D100:0W–D0:100W	Volume balance of the original sound (D) and chorus sound (W)
OUTPUT LEVEL	0–127	Output Level

33: 2 BAND FLANGER

A flanger that lets you apply an effect independently to the low-frequency and high-frequency ranges.

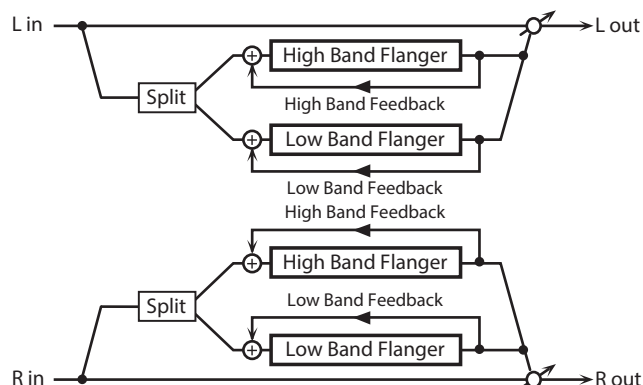

Parameter	Value	Explanation
LOW RATE #	0.05–10.00 Hz, note	Rate at which the low-range flanger sound is modulated
LOW DEPTH	0–127	Modulation depth for the low-range flanger sound
LOW FEEDBACK #	98–+98 %	Proportion of the low-range flanger sound that is to be returned to the input (negative values invert the phase)
LOW PHASE	0–180 deg	Spaciousness of the low-range flanger sound
LOW PRE DELAY	0.0–100 msec	Delay time from when the original sound is heard to when the low-range flanger sound is heard
HIGH RATE #	0.05–10.00 Hz, note	Rate at which the high-range flanger sound is modulated
HIGH DEPTH	0–127	Modulation depth for the high-range flanger sound
HIGH FEEDBACK #	-98–+98 %	Proportion of the high-range flanger sound that is to be returned to the input (negative values invert the phase)
HIGH PHASE	0–180 deg	Spaciousness of the high-range flanger sound
HIGH PRE DELAY	0.0–100 msec	Delay time from when the original sound is heard to when the high-range flanger sound is heard
SPLIT FREQUENCY	200–8000 Hz	Frequency at which the low and high ranges will be divided
BALANCE #	D100:0W–D0:100W	Volume balance of the original sound (D) and flanger sound (W)
OUTPUT LEVEL	0–127	Output Level

34: 2 BAND STEP FLANGER

A step flanger that lets you apply an effect independently to the low-frequency and high-frequency ranges.

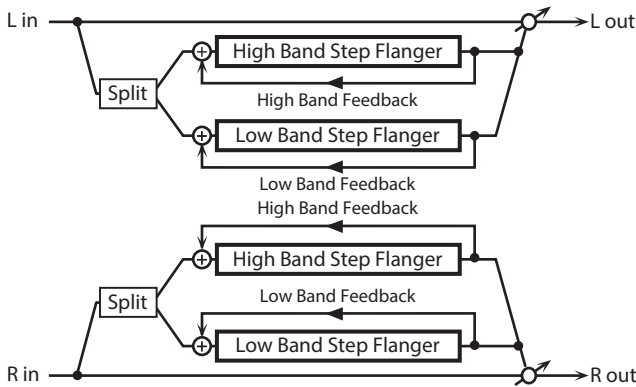

Parameter	Value	Explanation
LOW RATE #	0.05–10.00 Hz, note	Rate at which the low-range flanger sound is modulated
LOW DEPTH	0–127	Modulation depth for the low-range flanger sound
LOW FEEDBACK #	-98–+98 %	Proportion of the low-range flanger sound that is to be returned to the input (negative values invert the phase)
LOW PHASE	0–180 deg	Spaciousness of the low-range flanger sound
LOW PRE DELAY	0.0–100 msec	Delay time from when the original sound is heard to when the low-range flanger sound is heard
HIGH RATE #	0.05–10.00 Hz, note	Rate at which the high-range flanger sound is modulated
HIGH DEPTH	0–127	Modulation depth for the high-range flanger sound
HIGH FEEDBACK #	-98–+98 %	Proportion of the high-range flanger sound that is to be returned to the input (negative values invert the phase)
HIGH PHASE	0–180 deg	Spaciousness of the high-range flanger sound
HIGH PRE DELAY	0.0–100 msec	Delay time from when the original sound is heard to when the high-range flanger sound is heard
LOW STEP RATE #	0.10–20.00 Hz, note	Rate at which the steps will cycle for the low-range flanger sound
HIGH STEP RATE #	0.10–20.00 Hz, note	Rate at which the steps will cycle for the high-range flanger sound
SPLIT FREQUENCY	200–8000 Hz	Frequency at which the low and high ranges will be divided
BALANCE #	D100:0W–D0:100W	Volume balance of the original sound (D) and flanger sound (W)
OUTPUT LEVEL	0–127	Output Level

35: OVERDRIVE

Creates a soft distortion similar to that produced by vacuum tube amplifiers.

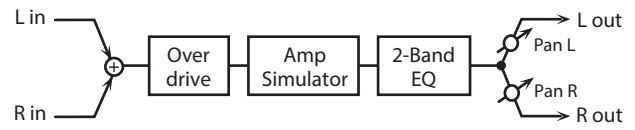

Parameter	Value	Explanation
DRIVE #	0–127	Degree of distortion Also changes the volume.
AMP SIMULATOR TYPE	SMALL, BUILT-IN, 2-STACK, 3-STACK	Type of guitar amp SMALL : small amp BUILT-IN : single-unit type amp 2-STACK : large double stack amp 3-STACK : large triple stack amp
EQ GAIN LOW	-15–+15 dB	Amount of boost/cut for the low-frequency range
EQ GAIN HIGH	-15–+15 dB	Amount of boost/cut for the high-frequency range
OUTPUT PAN #	L64–63R	Stereo location of the output sound
OUTPUT LEVEL	0–127	Output Level

36: DISTORTION

Produces a more intense distortion than Overdrive. The parameters are the same as for **“35: OVERDRIVE.”**

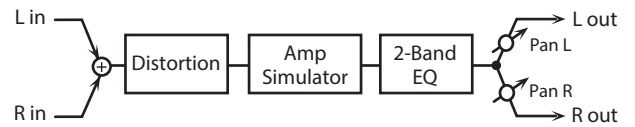

37: VS OVERDRIVE

This is an overdrive that provides heavy distortion.

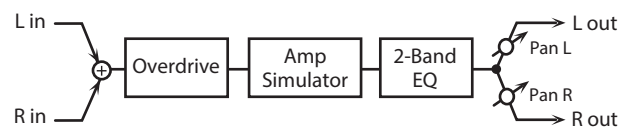

Parameter	Value	Explanation
DRIVE #	0–127	Degree of distortion Also changes the volume.
TONE #	0–127	Sound quality of the Overdrive effect
AMP SIMULATOR SW	OFF, ON	Turns the Amp Simulator on/off.
AMP SIMULATOR TYPE	SMALL, BUILT-IN, 2-STACK, 3-STACK	Type of guitar amp SMALL : small amp BUILT-IN : single-unit type amp 2-STACK : large double stack amp 3-STACK : large triple stack amp
EQ GAIN LOW	-15–+15 dB	Amount of boost/cut for the low-frequency range
EQ GAIN HIGH	-15–+15 dB	Amount of boost/cut for the high-frequency range
OUTPUT PAN #	L64–63R	Stereo location of the output sound
OUTPUT LEVEL	0–127	Output Level

38: VS DISTORTION

This is a distortion effect that provides heavy distortion. The parameters are the same as for "37: VS OVERDRIVE."

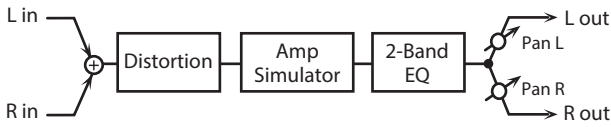

39: GUITAR AMP SIMULATOR

This is an effect that simulates the sound of a guitar amplifier.

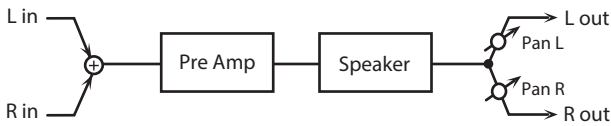

Parameter	Value	Explanation
AMP SW	OFF, ON	Turns the amp switch on/off.
AMP SIMULATOR TYPE	JC-120, CLEAN TWIN, MATCH DRIVE, BG LEAD, MS1959I, MS1959II, MS1959I+II, SLDN LEAD, METAL 5150, METAL LEAD, OD-1, OD-2 TURBO, DISTORTION, FUZZ	Type of guitar amp
AMP VOLUME #	0-127	Volume and amount of distortion of the amp
AMP MASTER #	0-127	Volume of the entire pre-amp
AMP GAIN	LOW, MIDDLE, HIGH	Amount of pre-amp distortion
AMP PRESENCE	0-127	Tone for the ultra-high frequency range
AMP BRIGHT	OFF, ON	Turning this "On" produces a sharper and brighter sound. * This parameter applies to the "JC-120," "CLEAN TWIN," and "BG LEAD" Pre Amp Types.
AMP BASS		Tone of the bass/mid/treble frequency range
AMP MIDDLE	0-127	* Middle cannot be set if "MATCH DRIVE" is selected as the Pre Amp Type.
AMP TREBLE		
SPEAKER SW	OFF, ON	Selects whether the sound will be sent through the speaker simulation (ON) or not (OFF)
SPEAKER TYPE	(See the table below.)	Type of speaker
MIC SETTING	1, 2, 3	Adjusts the location of the microphone that is recording the sound of the speaker. This can be adjusted in three steps, with the microphone becoming more distant in the order of 1, 2, and 3.
MIC LEVEL	0-127	Volume of the microphone
MIC DIRECT	0-127	Volume of the direct sound
OUTPUT LEVEL #	0-127	Output Level
OUTPUT PAN #	L64-63R	Stereo location of the output sound

Specifications of each Speaker Type

The speaker column indicates the diameter of each speaker unit (in inches) and the number of units.

Type	Cabinet	Speaker	Microphone
SMALL 1	small open-back enclosure	10	dynamic
SMALL 2	small open-back enclosure	10	dynamic
MIDDLE	open back enclosure	12 x 1	dynamic
JC-120	open back enclosure	12 x 2	dynamic
BUILT-IN 1	open back enclosure	12 x 2	dynamic
BUILT-IN 2	open back enclosure	12 x 2	condenser
BUILT-IN 3	open back enclosure	12 x 2	condenser
BUILT-IN 4	open back enclosure	12 x 2	condenser
BUILT-IN 5	open back enclosure	12 x 2	condenser
BG STACK 1	sealed enclosure	12 x 2	condenser
BG STACK 2	large sealed enclosure	12 x 2	condenser
MS STACK 1	large sealed enclosure	12 x 4	condenser
MS STACK 2	large sealed enclosure	12 x 4	condenser
METAL STACK	large double stack	12 x 4	condenser
2-STACK	large double stack	12 x 4	condenser
3-STACK	large triple stack	12 x 4	condenser

40: COMPRESSOR

Flattens out high levels and boosts low levels, smoothing out fluctuations in volume.

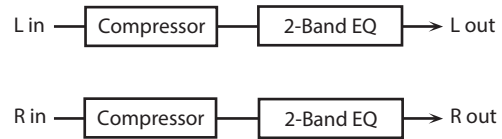

Parameter	Value	Explanation
ATTACK #	0-127	Sets the speed at which compression starts
THRESHOLD #	0-127	Adjusts the volume at which compression begins
POST GAIN	0-+18 dB	Adjusts the output gain.
EQ GAIN LOW	-15-+15 dB	Amount of boost/cut for the low-frequency range
EQ GAIN HIGH	-15-+15 dB	Amount of boost/cut for the high-frequency range
OUTPUT LEVEL #	0-127	Output Level

41: LIMITER

Compresses signals that exceed a specified volume level, preventing distortion from occurring.

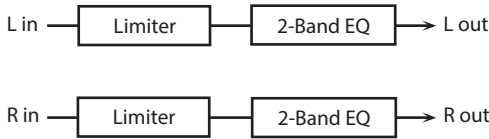

Parameter	Value	Explanation
THRESHOLD #	0-127	Adjusts the volume at which compression begins
RATIO	1.5:1, 2:1, 4:1, 100:1	Compression ratio
RELEASE #	0-127	Adjusts the time after the signal volume falls below the Threshold Level until compression is no longer applied.
POST GAIN	0-+18 dB	Adjusts the output gain.
EQ GAIN LOW	-15-+15 dB	Amount of boost/cut for the low-frequency range
EQ GAIN HIGH	-15-+15 dB	Amount of boost/cut for the high-frequency range
OUTPUT LEVEL #	0-127	Output Level

42: GATE

Cuts the reverb's decay according to the volume of the sound sent into the effect. Use this when you want to create an artificial-sounding decrease in the reverb's decay.

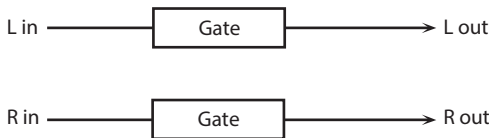

Parameter	Value	Explanation
MODE	GATE, DUCK	Type of gate GATE: The gate will close when the volume of the original sound decreases, cutting the original sound. DUCK (Duckling): The gate will close when the volume of the original sound increases, cutting the original sound.
ATTACK	0-127	Adjusts the time it takes for the gate to fully open after being triggered.
HOLD	0-127	Adjusts the time it takes for the gate to start closing after the source sound falls beneath the Threshold.
RELEASE	0-127	Adjusts the time it takes the gate to fully close after the hold time.
THRESHOLD #	0-127	Volume level at which the gate begins to close
BALANCE #	D100:0W-D0:100W	Volume balance between the direct sound (D) and the effect sound (W)
OUTPUT LEVEL	0-127	Output Level

43: DELAY

This is a stereo delay.

When Feedback Mode is NORMAL:

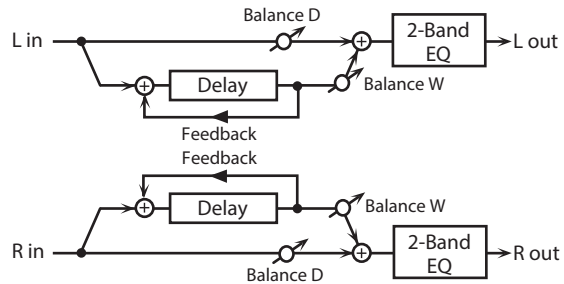

When Feedback Mode is CROSS:

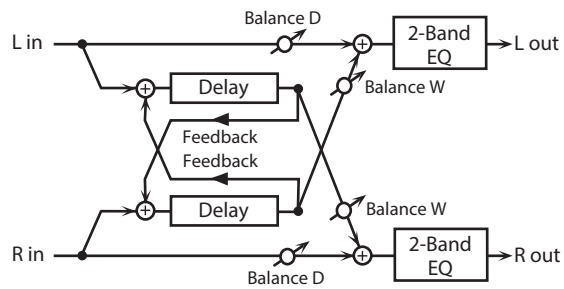

Parameter	Value	Explanation
DELAY TIME LEFT	0-1300 msec, note	Adjusts the time until the delay sound is heard.
DELAY TIME RIGHT		
FEEDBACK #	-98-+98 %	Adjusts the amount of the delay sound that's fed back into the effect. Negative (-) settings invert the phase.
MODE	NORMAL, CROSS	Selects the way in which delay sound is fed back into the effect. (See the figures above.)
HF DAMP	200-8000 Hz, BYPASS	Adjusts the frequency above which sound fed back to the effect is filtered out. If you don't want to filter out any high frequencies, set this parameter to BYPASS.
PHASE LEFT	NORMAL, INVERSE	Phase of the delay sound
PHASE RIGHT		NORMAL: non-inverted INVERT: inverted
EQ GAIN LOW	-15-+15 dB	Amount of boost/cut for the low-frequency range
EQ GAIN HIGH	-15-+15 dB	Amount of boost/cut for the high-frequency range
BALANCE #	D100:0W-D0:100W	Volume balance between the direct sound (D) and the delay sound (W)
OUTPUT LEVEL	0-127	Output Level

44: LONG DELAY

A delay that provides a long delay time.

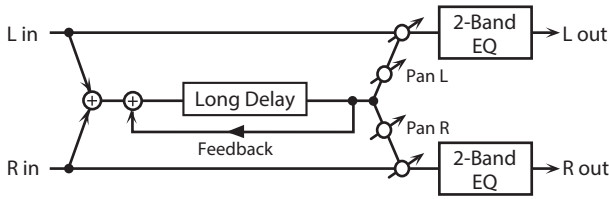

Parameter	Value	Explanation
TIME	0–2600 msec, note	Delay time from when the original sound is heard to when the delay sound is heard
FEEDBACK #	-98–+98 %	Proportion of the delay sound that is to be returned to the input (negative values invert the phase)
PHASE	NORMAL, INVERSE	Phase of the delay NORMAL: non-inverted INVERT: inverted
HF DAMP	200–8000 Hz, BYPASS	Frequency at which the high-frequency content of the delayed sound will be cut (BYPASS: no cut)
PAN #	L64–63R	Panning of the delay sound
EQ GAIN LOW	-15–+15 dB	Amount of boost/cut for the low-frequency range
EQ GAIN HIGH	-15–+15 dB	Amount of boost/cut for the high-frequency range
BALANCE #	D100:0W–D0:100W	Volume balance of the original sound (D) and delay sound (W)
OUTPUT LEVEL	0–127	Output Level

45: SERIAL DELAY

This delay connects two delay units in series. Feedback can be applied independently to each delay unit, allowing you to produce complex delay sounds.

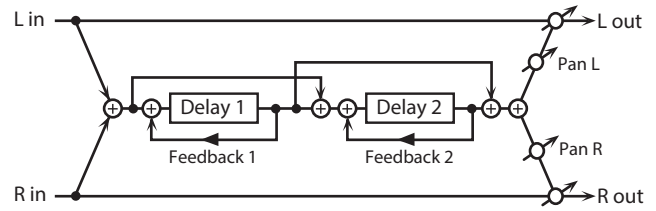

Parameter	Value	Explanation
DELAY 1 TIME	0–1300 msec, note	Delay time from when sound is input to delay 1 until the delay sound is heard
DELAY 1 FEEDBACK #	-98–+98 %	Proportion of the delay sound that is to be returned to the input of delay 1 (negative values invert the phase)
DELAY 1 HF DAMP	200–8000 Hz, BYPASS	Frequency at which the high-frequency content of the delayed sound of delay 1 will be cut (BYPASS: no cut)
DELAY 2 TIME	0–1300 msec, note	Delay time from when sound is input to delay 2 until the delay sound is heard
DELAY 2 FEEDBACK #	-98–+98 %	Proportion of the delay sound that is to be returned to the input of delay 2 (negative values invert the phase)
DELAY 2 HF DAMP	200–8000 Hz, BYPASS	Frequency at which the high-frequency content of the delayed sound of delay 2 will be cut (BYPASS: no cut)
PAN #	L64–63R	Panning of the delay sound
EQ GAIN LOW	-15–+15 dB	Amount of boost/cut for the low-frequency range
EQ GAIN HIGH	-15–+15 dB	Amount of boost/cut for the high-frequency range
BALANCE #	D100:0W–D0:100W	Volume balance of the original sound (D) and delay sound (W)
OUTPUT LEVEL	0–127	Output Level

46: MODULATION DELAY

Adds modulation to the delayed sound.

When Feedback Mode is NORMAL:

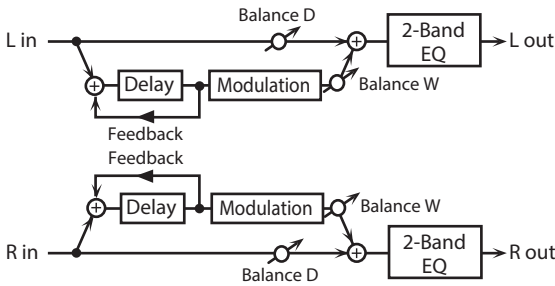

When Feedback Mode is CROSS:

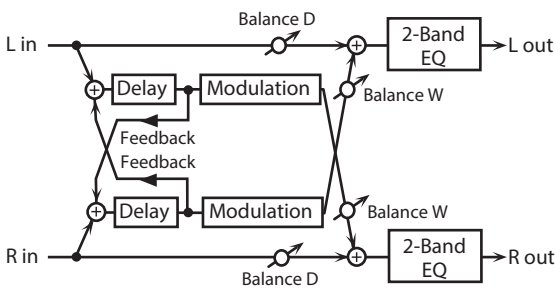

Parameter	Value	Explanation
TIME LEFT	0-1300 msec, note	Adjusts the time until the delay sound is heard.
TIME RIGHT		
FEEDBACK #	-98--+98 %	Adjusts the amount of the delay sound that's fed back into the effect. Negative (-) settings invert the phase.
MODE	NORMAL, CROSS	Selects the way in which delay sound is fed back into the effect. (See the figures above.)
HF DAMP	200-8000 Hz, BYPASS	Adjusts the frequency above which sound fed back to the effect is filtered out. If you don't want to filter out any high frequencies, set this parameter to BYPASS.
RATE #	0.05-10.00 Hz, note	Frequency of modulation
DEPTH	0-127	Depth of modulation
PHASE	0-180 deg	Spatial spread of the sound
EQ GAIN LOW	-15--+15 dB	Amount of boost/cut for the low-frequency range
EQ GAIN HIGH	-15--+15 dB	Amount of boost/cut for the high-frequency range
BALANCE #	D100:0W-D0:100W	Volume balance between the direct sound (D) and the delay sound (W)
OUTPUT LEVEL	0-127	Output Level

47: 3TAP PAN DELAY

Produces three delay sounds; center, left and right.

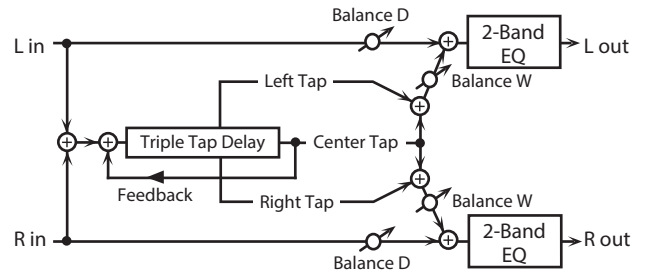

Parameter	Value	Explanation
TIME LEFT/CENTER/RIGHT	0-2600 msec, note	Adjusts the time from the original sound until the left, center, and right delayed sounds are heard
CENTER FEEDBACK #	-98--+98 %	Adjusts the amount of the delay sound that's fed back into the effect. Negative (-) settings invert the phase.
HF DAMP	200-8000 Hz, BYPASS	Adjusts the frequency above which sound fed back to the effect is filtered out. If you do not want to filter out any high frequencies, set this parameter to BYPASS.
LEVEL LEFT/CENTER/RIGHT	0-127	Volume of each delay sound
EQ GAIN LOW	-15--+15 dB	Amount of boost/cut for the low-frequency range
EQ GAIN HIGH	-15--+15 dB	Amount of boost/cut for the high-frequency range
BALANCE #	D100:0W-D0:100W	Volume balance between the direct sound (D) and the delay sound (W)
OUTPUT LEVEL	0-127	Output Level

48: 4TAP PAN DELAY

This effect has four delays.

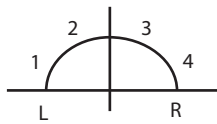
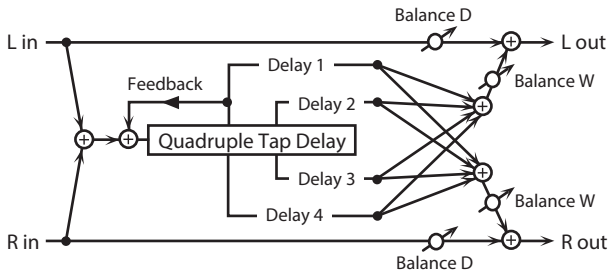

Stereo location of each delay

Parameter	Value	Explanation
TIME 1-4	0-2600 msec, note	Adjusts the time from the original sound until delay sounds 1-4 are heard
LEVEL 1-4	0-127	Volume of each delay
DELAY 1 FEEDBACK #	-98-+98 %	Adjusts the amount of the delay sound that's fed back into the effect. Negative (-) settings invert the phase.
DELAY 1 HF DAMP	200-8000 Hz, BYPASS	Adjusts the frequency above which sound fed back to the effect is filtered out. If you do not want to filter out any high frequencies, set this parameter to BYPASS.
EQ GAIN LOW	-15-+15 dB	Amount of boost/cut for the low-frequency range
EQ GAIN HIGH	-15-+15 dB	Amount of boost/cut for the high-frequency range
BALANCE #	D100:0W-D0:100W	Volume balance between the direct sound (D) and the delay sound (W)
OUTPUT LEVEL	0-127	Output Level

49: MULTI TAP DELAY

This effect provides four delays. Each of the Delay Time parameters can be set to a note length based on the selected tempo. You can also set the panning and level of each delay sound.

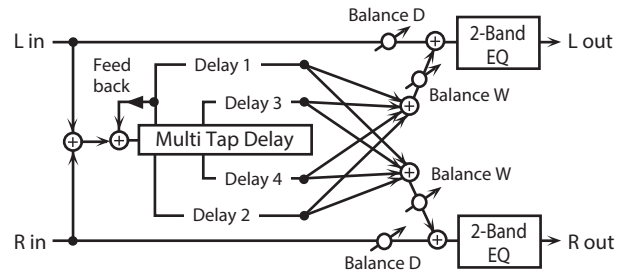

Parameter	Value	Explanation
TIME 1-4	0-2600 msec, note	Adjusts the time until Delays 1-4 are heard.
LEVEL 1-4	0-127	Output level of Delays 1-4
DELAY 1 FEEDBACK #	-98-+98 %	Adjusts the amount of the delay sound that's fed back into the effect. Negative (-) settings invert the phase.
DELAY 1 HF DAMP	200-8000 Hz, BYPASS	Adjusts the frequency above which sound fed back to the effect is filtered out. If you don't want to filter out any the high frequencies, set this parameter to BYPASS.
PAN 1-4	L64-63R	Stereo location of Delays 1-4
EQ GAIN LOW	-15-+15 dB	Amount of boost/cut for the low-frequency range
EQ GAIN HIGH	-15-+15 dB	Amount of boost/cut for the high-frequency range
BALANCE #	D100:0W-D0:100W	Volume balance between the direct sound (D) and the effect sound (W)
OUTPUT LEVEL	0-127	Output Level

50: REVERSE DELAY

This is a reverse delay that adds a reversed and delayed sound to the input sound. A tap delay is connected immediately after the reverse delay.

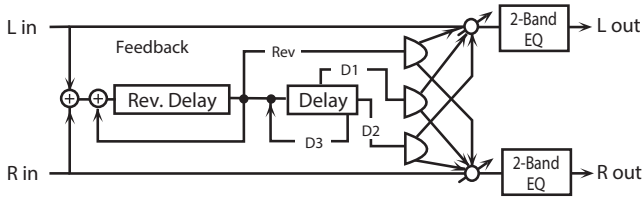

Parameter	Value	Explanation
REV DELAY TIME	0-1300 msec, note	Delay time from when sound is input into the reverse delay until the delay sound is heard
REV DELAY FEEDBACK #	-98-+98 %	Proportion of the delay sound that is to be returned to the input of the reverse delay (negative values invert the phase)
REV DELAY HF DAMP	200-8000 Hz, BYPASS	Frequency at which the high-frequency content of the reverse-delayed sound will be cut (BYPASS: no cut)
REV DELAY THRESHOLD	0-127	Volume at which the reverse delay will begin to be applied
REV DELAY LEVEL	0-127	Volume of the reverse delay sound
REV DELAY PAN	L64-63R	Panning of the reverse delay sound
TAP DELAY TIME 1-3	0-1300 msec, note	Delay time from when sound is input into the tap delay until the delay sound is heard
DELAY 3 FEEDBACK #	-98-+98 %	Proportion of the delay sound that is to be returned to the input of the tap delay (negative values invert the phase)
TAP DELAY HF DAMP	200-8000 Hz, BYPASS	Frequency at which the high-frequency content of the tap delay sound will be cut (BYPASS: no cut)
TAP DELAY PAN 1-2	L64-63R	Panning of the tap delay sounds
TAP DELAY LEVEL 1-2	0-127	Volume of the tap delay sounds
EQ GAIN LOW	-15-+15 dB	Amount of boost/cut for the low-frequency range
EQ GAIN HIGH	-15-+15 dB	Amount of boost/cut for the high-frequency range
BALANCE #	D100:0W-D0:100W	Volume balance of the original sound (D) and delay sound (W)
OUTPUT LEVEL	0-127	Output Level

51: SHUFFLE DELAY

Adds a shuffle to the delay sound, giving the sound a bouncy delay effect with a swing feel.

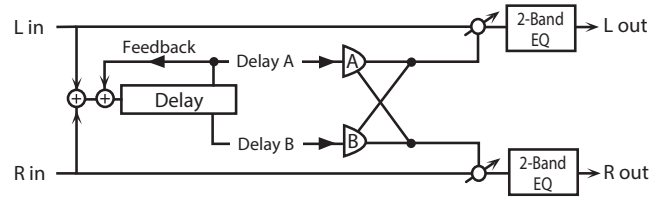

Parameter	Value	Explanation
TIME #	0-2600 msec, note	Adjusts the delay time from the direct sound until the delay sound is heard.
SHUFFLE RATE #	0-100	Adjusts the ratio (as a percentage) of the time that elapses before Delay B sounds relative to the time that elapses before the Delay A sounds. When set to 100, the delay times are the same.
ACCELERATION	0-15	Adjusts the speed which the Delay Time changes from the current setting to its specified new setting.
FEEDBACK #	-98-+98 %	Adjusts the amount of the delay that's fed back into the effect. Negative (-) settings invert the phase.
HF DAMP	200-8000 Hz, BYPASS	Adjusts the frequency above which sound fed back to the effect is filtered out. If you don't want to filter out any high frequencies, set this parameter to BYPASS.
PAN A/B	L64-63R	Stereo location of Delay A/B
LEVEL A/B	0-127	Volume of delay A/B
EQ GAIN LOW	-15-+15 dB	Amount of boost/cut for the low-frequency range
EQ GAIN HIGH	-15-+15 dB	Amount of boost/cut for the high-frequency range
BALANCE #	D100:0W-D0:100W	Volume balance between the direct sound (D) and the effect sound (W)
OUTPUT LEVEL	0-127	Output Level

52: 3D DELAY

This applies a 3D effect to the delay sound. The delay sound will be positioned 90 degrees left and 90 degrees right.

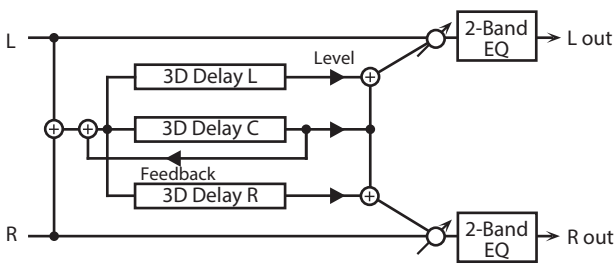

Parameter	Value	Explanation
TIME LEFT		
TIME CENTER	0-2600 msec, note	Adjusts the delay time from the direct sound until the delay sound is heard.
TIME RIGHT		
CENTER FEEDBACK #	-98-+98 %	Adjusts the proportion of the delay sound that is fed back into the effect. Negative (-) settings will invert the phase.
HF DAMP	200-8000 Hz, BYPASS	Adjusts the frequency above which sound fed back to the effect will be cut. If you do not want to cut the high frequencies, set this parameter to BYPASS.
LEVEL LEFT		
LEVEL CENTER	0-127	Output level of the delay sound
LEVEL RIGHT		
EQ GAIN LOW	-15-+15 dB	Amount of boost/cut for the low-frequency range
EQ GAIN HIGH	-15-+15 dB	Amount of boost/cut for the high-frequency range
BALANCE #	D100:0W-D0:100W	Volume balance between the direct sound (D) and the effect sound (W)
OUTPUT MODE	SPEAKER, PHONES	Adjusts the method that will be used to hear the sound that is output to the OUTPUT. The optimal 3D effect will be achieved if you select SPEAKER when using speakers, or PHONES when using headphones.
OUTPUT LEVEL	0-127	Output Level

53: TIME CTRL DELAY

A stereo delay in which the delay time can be varied smoothly.

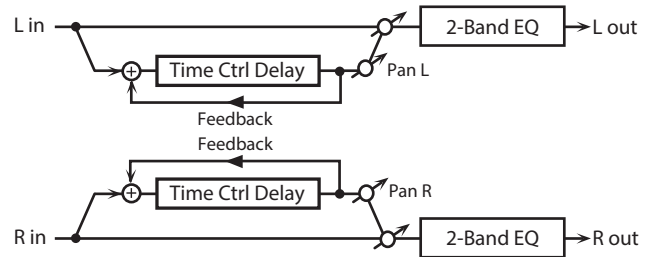

Parameter	Value	Explanation
TIME #	0-1300 msec, note	Adjusts the delay time from the direct sound until the delay sound is heard.
ACCELERATION	0-15	Adjusts the speed which the Delay Time changes from the current setting to a specified new setting. The rate of change for the Delay Time directly affects the rate of pitch change.
FEEDBACK #	-98-+98 %	Adjusts the amount of the delay that's fed back into the effect. Negative (-) settings invert the phase.
HF DAMP	200-8000 Hz, BYPASS	Adjusts the frequency above which sound fed back to the effect is filtered out. If you do not want to filter out any high frequencies, set this parameter to BYPASS.
EQ GAIN LOW	-15-+15 dB	Amount of boost/cut for the low-frequency range
EQ GAIN HIGH	-15-+15 dB	Amount of boost/cut for the high-frequency range
BALANCE #	D100:0W-D0:100W	Volume balance between the direct sound (D) and the delay sound (W)
OUTPUT LEVEL	0-127	Output Level

54: LONG TIME CTRL DELAY

A delay in which the delay time can be varied smoothly, and allowing an extended delay to be produced.

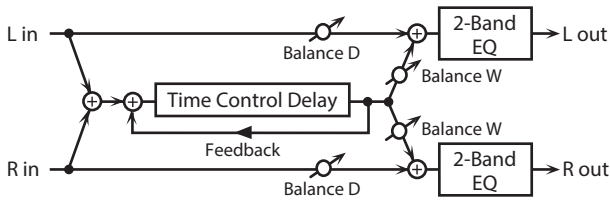

Parameter	Value	Explanation
TIME #	0–2600 msec, note	Adjusts the delay time from the direct sound until the delay sound is heard.
ACCELERATION	0–15	Adjusts the speed which the Delay Time changes from the current setting to a specified new setting. The rate of change for the Delay Time directly affects the rate of pitch change.
FEEDBACK #	-98–+98 %	Adjusts the amount of the delay that's fed back into the effect. Negative (-) settings invert the phase.
HF DAMP	200–8000 Hz, BYPASS	Adjusts the frequency above which sound fed back to the effect is filtered out. If you do not want to filter out any high frequencies, set this parameter to BYPASS.
PAN #	L64–63R	Stereo location of the delay
EQ GAIN LOW	-15–+15 dB	Amount of boost/cut for the low-frequency range
EQ GAIN HIGH	-15–+15 dB	Amount of boost/cut for the high-frequency range
BALANCE #	D100:0W–D0:100W	Volume balance between the direct sound (D) and the delay sound (W)
OUTPUT LEVEL	0–127	Output Level

55: TAPE ECHO

A virtual tape echo that produces a realistic tape delay sound. This simulates the tape echo section of a Roland RE-201 Space Echo.

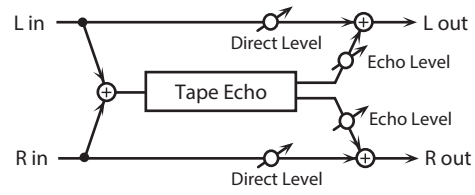

Parameter	Value	Explanation
MODE	S, M, L, S+M, S+L, M+L, S+M+L	Combination of playback heads to use Select from three different heads with different delay times. S : short M : middle L : long
REPEAT RATE #	0–127	Tape speed Increasing this value will shorten the spacing of the delayed sounds.
INTENSITY #	0–127	Amount of delay repeats
BASS	-15–+15 dB	Boost/cut for the lower range of the echo sound
TREBLE	-15–+15 dB	Boost/cut for the upper range of the echo sound
HEAD PAN S		Independent panning for the short, middle, and long playback heads
HEAD PAN M	L64–63R	
HEAD PAN L		
DISTORTION	0–5	Amount of tape-dependent distortion to be added This simulates the slight tonal changes that can be detected by signal-analysis equipment. Increasing this value will increase the distortion.
WOW/FLUTTER RATE	0–127	Speed of wow/flutter (complex variation in pitch caused by tape wear and rotational irregularity)
WOW/FLUTTER DEPTH	0–127	Depth of wow/flutter
ECHO LEVEL #	0–127	Volume of the echo sound
DIRECT LEVEL #	0–127	Volume of the original sound
OUTPUT LEVEL	0–127	Output level

56: LOFI NOISE

In addition to a lo-fi effect, this adds various types of noise such as white noise and disc noise.

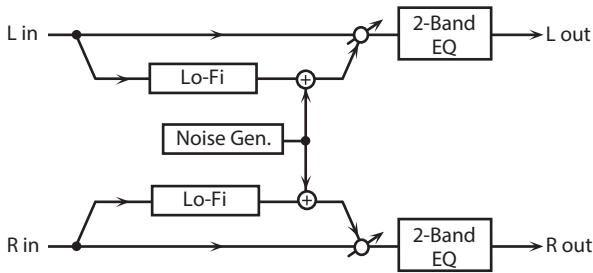

Parameter	Value	Explanation
LOFI TYPE	1-9	Degrades the sound quality. The sound quality grows poorer as this value is increased.
POST FILTER TYPE	OFF, LPF, HPF	Type of filter that follows the LoFi effect OFF: no filter is used LPF: cuts the frequency range above the Cutoff HPF: cuts the frequency range below the Cutoff
POST FILTER CUTOFF	200-8000 Hz	Center frequency of the filter
W/P NOISE TYPE	WHITE, PINK	Switch between white noise and pink noise.
W/P NOISE LPF	200-8000 Hz, BYPASS	Center frequency of the low pass filter applied to the white/pink noise (BYPASS: no cut)
W/P NOISE LEVEL #	0-127	Volume of the white/pink noise
DISC NOISE TYPE	LP, EP, SP, RND	Type of record noise The frequency at which the noise is heard depends on the selected type.
DISC NOISE LPF	200-8000 Hz, BYPASS	Adjusts the cutoff frequency of the low pass filter applied to the record noise. If you don't want to filter out any high frequencies, set this parameter to BYPASS.
DISC NOISE LEVEL #	0-127	Volume of the record noise
HUM TYPE	50Hz, 60Hz	Frequency of the hum noise
HUM LPF	200-8000 Hz, BYPASS	Center frequency of the low pass filter applied to the hum noise (BYPASS: no cut)
HUM LEVEL #	0-127	Volume of the hum noise
EQ GAIN LOW	-15-+15 dB	Amount of boost/cut for the low-frequency range
EQ GAIN HIGH	-15-+15 dB	Amount of boost/cut for the high-frequency range
BALANCE #	D100:0W-D0:100W	Volume balance between the direct sound (D) and the effect sound (W)
OUTPUT LEVEL	0-127	Output Level

57: LOFI COMPRESS

This is an effect that intentionally degrades the sound quality for creative purposes.

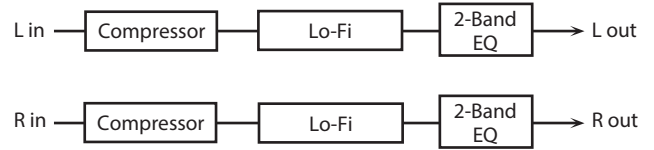

Parameter	Value	Explanation
LOFI TYPE	1-9	Degrades the sound quality. The sound quality grows poorer as this value is increased.
PRE FILTER TYPE	1-6	Selects the type of filter applied to the sound before it passes through the Lo-Fi effect. 1: Compressor off 2-6: Compressor on
POST FILTER TYPE	OFF, LPF, HPF	Type of filter OFF: no filter is used LPF: cuts the frequency range above the Cutoff HPF: cuts the frequency range below the Cutoff
POST FILTER CUTOFF	200-8000 Hz	Basic frequency of the Post Filter
EQ GAIN LOW	-15-+15 dB	Amount of boost/cut for the low-frequency range
EQ GAIN HIGH	-15-+15 dB	Amount of boost/cut for the high-frequency range
BALANCE #	D100:0W-D0:100W	Volume balance between the direct sound (D) and the effect sound (W)
OUTPUT LEVEL #	0-127	Output Level

58: LOFI RADIO

In addition to a Lo-Fi effect, this effect also generates radio noise.

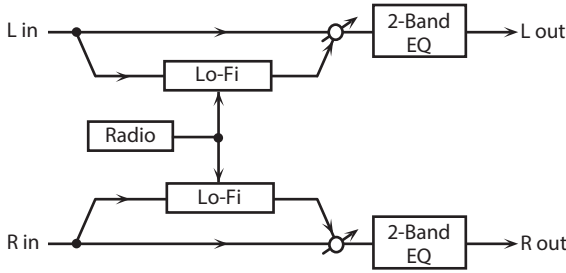

Parameter	Value	Explanation
LOFI TYPE	1-9	Degrades the sound quality. The sound quality grows poorer as this value is increased.
POST FILTER TYPE	OFF, LPF, HPF	Type of filter OFF : no filter is used LPF : cuts the frequency range above the Cutoff HPF : cuts the frequency range below the Cutoff
POST FILTER CUTOFF	200-8000 Hz	Basic frequency of the Post Filter
RADIO NOISE DETUNE #	0-127	Simulates the tuning noise of a radio. As this value is raised, the tuning drifts further.
RADIO NOISE LEVEL #	0-127	Volume of the radio noise
EQ GAIN LOW	-15-+15 dB	Amount of boost/cut for the low-frequency range
EQ GAIN HIGH	-15-+15 dB	Amount of boost/cut for the high-frequency range
BALANCE #	D100:0W-D0:100W	Volume balance between the direct sound (D) and the effect sound (W)
OUTPUT LEVEL	0-127	Output Level

59: TELEPHONE

This effect produces a muffled sound, like that heard through a telephone.

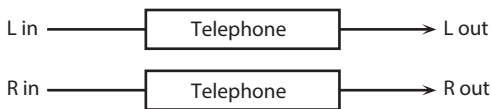

Parameter	Value	Explanation
VOICE QUALITY #	0-15	Audio quality of the telephone voice
TREBLE	-15-+15 dB	Amount of boost/cut for the high frequency range
BALANCE #	D100:0W-D0:100W	Volume balance between the direct sound (D) and the effect sound (W)
OUTPUT LEVEL	0-127	Output Level

60: PHONOGRAPH

Simulates a sound recorded on an analog record and played back on a record player. This effect also simulates the various types of noise that are typical of a record, and even the rotational irregularities of an old turntable.

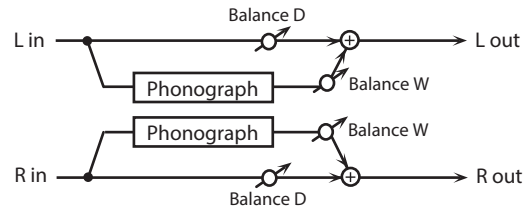

Parameter	Value	Explanation
SIGNAL DISTORTION	0-127	Degree of distortion
FREQUENCY RANGE	0-127	Frequency response of the playback system Decreasing this value will produce the impression of an old system with a poor frequency response.
DISC TYPE	LP, EP, SP	Rotational speed of the turntable This will affect the cycle of the scratch noise.
NOISE LEVEL SCRATCH	0-127	Amount of noise due to scratches on the record
NOISE LEVEL DUST	0-127	Volume of noise due to dust on the record
NOISE LEVEL HISS	0-127	Volume of continuous hiss
NOISE LEVEL TOTAL	0-127	Volume of overall noise
WOW	0-127	Depth of long-cycle rotational irregularity
FLUTTER	0-127	Depth of short-cycle rotational irregularity
WOW/FLUTTER RANDOM	0-127	Depth of indefinite-cycle rotational irregularity
WOW/FLUTTER TOTAL #	0-127	Depth of overall rotational irregularity
BALANCE #	D100:0W-D0:100W	Volume balance between the direct sound (D) and the effect sound (W)
OUTPUT LEVEL	0-127	Output Level

61: PITCH SHIFTER

A stereo pitch shifter.

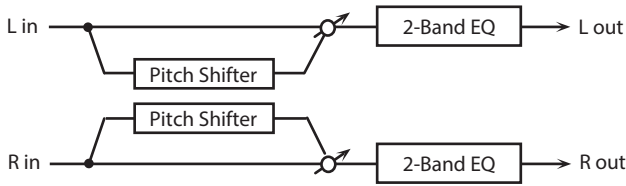

Parameter	Value	Explanation
COARSE #1	-24--+12 semi	Adjusts the pitch of the pitch shifted sound in semitone steps.
FINE #1	-100--+100 cent	Adjusts the pitch of the pitch shifted sound in 2-cent steps.
DELAY TIME	0-1300 msec, note	Adjusts the delay time from the direct sound until the pitch shifted sound is heard.
FEEDBACK #	-98--+98 %	Adjusts the proportion of the pitch shifted sound that is fed back into the effect. Negative (-) settings will invert the phase.
EQ GAIN LOW	-15--+15 dB	Amount of boost/cut for the low-frequency range
EQ GAIN HIGH	-15--+15 dB	Amount of boost/cut for the high-frequency range
BALANCE #	D100:0W-D0:100W	Volume balance between the direct sound (D) and the pitch shifted sound (W)
OUTPUT LEVEL	0-127	Output Level

62: 2VOICE PITCH SHIFTER

Shifts the pitch of the original sound. This 2-voice pitch shifter has two pitch shifters, and can add two pitch shifted sounds to the original sound.

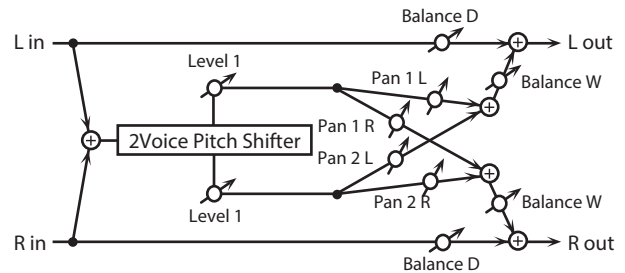

Parameter	Value	Explanation
PITCH1 COARSE #1	-24--+12 semi	Adjusts the pitch of Pitch Shift 1 in semitone steps.
PITCH1 FINE #1	-100--+100 cent	Adjusts the pitch of Pitch Shift 1 in 2-cent steps.
PITCH1 DELAY	0-1300 msec, note	Adjusts the delay time from the direct sound until the Pitch Shift 1 sound is heard.
PITCH1 FEEDBACK #	-98--+98 %	Adjusts the proportion of the pitch shifted sound that is fed back into the effect. Negative (-) settings will invert the phase.
PITCH1 LEVEL	0-127	Volume of the Pitch Shift 1 sound
PITCH1 PAN #	L64-63R	Stereo location of the Pitch Shift 1 sound
PITCH2 COARSE #2	24--+12 semi	Settings of the Pitch Shift 2 sound. The parameters are the same as for the Pitch Shift 1 sound.
PITCH2 FINE #2	-100--+100 cent	
PITCH2 DELAY	0-1300 msec, note	
PITCH2 FEEDBACK #	-98--+98 %	
PITCH2 LEVEL	0-127	
PITCH2 PAN #	L64-63R	
EQ GAIN LOW	-15--+15 dB	Amount of boost/cut for the low-frequency range
EQ GAIN HIGH	-15--+15 dB	Amount of boost/cut for the high-frequency range
BALANCE #	D100:0W-D0:100W	Volume balance between the direct sound (D) and the pitch shifted sound (W)
OUTPUT LEVEL	0-127	Output Level

63: STEP PITCH SHIFTER

A pitch shifter in which the amount of pitch shift is varied by a 16-step sequence.

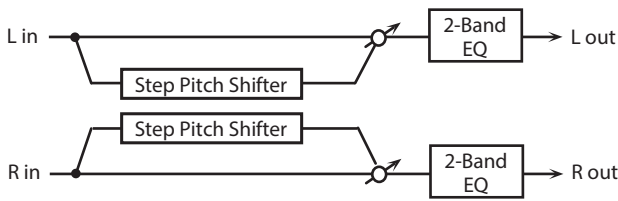

Parameter	Value	Explanation
RATE #	0.05–10.0 Hz, note	Rate at which the 16-step sequence will cycle
ATTACK #	0–127	Speed at which the amount of pitch shift changes between steps
GATE TIME #	0–127	Duration of the pitch shifted sound at each step
FINE	-100–+100 cent	Pitch shift adjustment for all steps (2-cent units)
DELAY TIME	0–1300 msec, note	Adjusts the delay time from the direct sound until the pitch shifted sound is heard.
FEEDBACK #	-98–+98 %	Proportion of the pitch-shifted sound that is to be returned to the input (negative values invert the phase)
STEP 1–16	-24–+12 semi	Amount of pitch shift at each step (semitone units)
EQ GAIN LOW	-15–+15 dB	Amount of boost/cut for the low-frequency range
EQ GAIN HIGH	-15–+15 dB	Amount of boost/cut for the high-frequency range
BALANCE #	D100:0W–D0:100W	Volume balance of the original sound (D) and pitch-shifted sound (W)
OUTPUT LEVEL	0–127	Output Level

MEMO

You can use multi-effect control to make the step sequence play again from the beginning (p. 38).

64: REVERB

Adds reverberation to the sound, simulating an acoustic space.

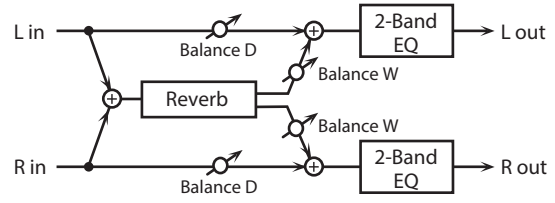

Parameter	Value	Explanation
TYPE	ROOM1, ROOM2, STAGE1, STAGE2, HALL1, HALL2	Type of reverb ROOM1 : dense reverb with short decay ROOM2 : sparse reverb with short decay STAGE1 : reverb with greater late reverberation STAGE2 : reverb with strong early reflections HALL1 : reverb with clear reverberance HALL2 : reverb with rich reverberance
PRE DELAY	0.0–100 msec	Adjusts the delay time from the direct sound until the reverb sound is heard.
TIME #	0–127	Time length of reverberation
HF DAMP	200–8000 Hz, BYPASS	Adjusts the frequency above which the reverberant sound will be cut. As the frequency is set lower, more of the high frequencies will be cut, resulting in a softer and more muted reverberance. If you do not want to cut the high frequencies, set this parameter to BYPASS.
EQ GAIN LOW	-15–+15 dB	Amount of boost/cut for the low-frequency range
EQ GAIN HIGH	-15–+15 dB	Amount of boost/cut for the high-frequency range
BALANCE #	D100:0W–D0:100W	Volume balance between the direct sound (D) and the reverb sound (W)
OUTPUT LEVEL	0–127	Output Level

65: GATED REVERB

This is a special type of reverb in which the reverberant sound is cut off before its natural length.

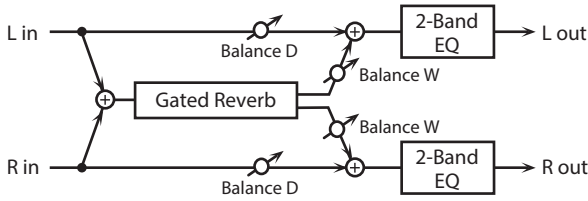

Parameter	Value	Explanation
TYPE	NORMAL, REVERSE, SWEEP1, SWEEP2	Type of reverb NORMAL: conventional gated reverb REVERSE: backwards reverb SWEEP1: the reverberant sound moves from right to left SWEEP2: the reverberant sound moves from left to right
PRE DELAY	0.0–100 msec	Adjusts the delay time from the direct sound until the reverb sound is heard.
GATE TIME	5–500 msec	Time length of reverberation
EQ GAIN LOW	-15–+15 dB	Amount of boost/cut for the low-frequency range
EQ GAIN HIGH	-15–+15 dB	Amount of boost/cut for the high-frequency range
BALANCE #	D100:0W–D0:100W	Volume balance between the direct sound (D) and the reverb sound (W)
OUTPUT LEVEL #	0–127	Output Level

66: OVERDRIVE → CHORUS

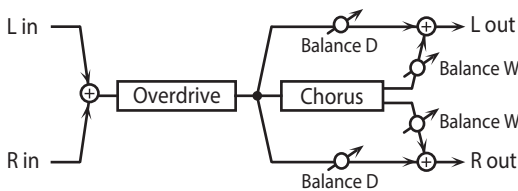

Parameter	Value	Explanation
OVERDRIVE DRIVE #	0–127	Degree of distortion Also changes the volume.
OVERDRIVE PAN #	L64–63R	Stereo location of the overdrive sound
CHORUS RATE #	0.05–10.00 Hz, note	Frequency of modulation
CHORUS DEPTH	0–127	Depth of modulation
CHORUS PRE DELAY	0.0–100 msec	Adjusts the delay time from the direct sound until the chorus sound is heard.
CHORUS BALANCE #	D100:0W–D0:100W	Adjusts the volume balance between the sound that is sent through the chorus (W) and the sound that is not sent through the chorus (D).
OUTPUT LEVEL	0–127	Output Level

67: OVERDRIVE → FLANGER

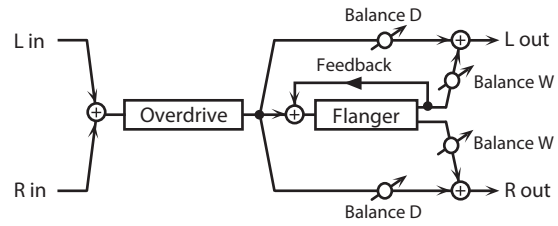

Parameter	Value	Explanation
OVERDRIVE DRIVE #	0–127	Degree of distortion Also changes the volume.
OVERDRIVE PAN #	L64–63R	Stereo location of the overdrive sound
FLANGER RATE #	0.05–10.00 Hz, note	Frequency of modulation
FLANGER DEPTH	0–127	Depth of modulation
FLANGER FEEDBACK #	-98–+98 %	Adjusts the proportion of the flanger sound that is fed back into the effect. Negative (-) settings will invert the phase.
FLANGER PRE DELAY	0.0–100 msec	Adjusts the delay time from when the direct sound begins until the flanger sound is heard.
FLANGER BALANCE #	D100:0W–D0:100W	Adjusts the volume balance between the sound that is sent through the flanger (W) and the sound that is not sent through the flanger (D).
OUTPUT LEVEL	0–127	Output Level

68: OVERDRIVE → DELAY

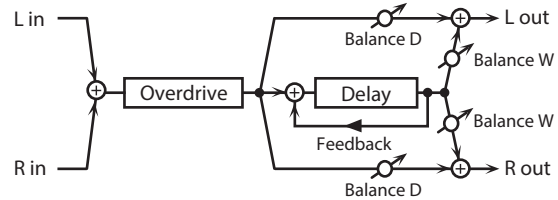

Parameter	Value	Explanation
OVERDRIVE DRIVE #	0–127	Degree of distortion Also changes the volume.
OVERDRIVE PAN #	L64–63R	Stereo location of the overdrive sound
DELAY TIME	0–2600 msec, note	Adjusts the delay time from the direct sound until the delay sound is heard.
DELAY FEEDBACK #	98–+98 %	Adjusts the proportion of the delay sound that is fed back into the effect. Negative (-) settings will invert the phase.
DELAY HF DAMP	200–8000 Hz, BYPASS	Adjusts the frequency above which sound fed back to the effect will be cut. If you do not want to cut the high frequencies, set this parameter to BYPASS.
DELAY BALANCE #	D100:0W–D0:100W	Adjusts the volume balance between the sound that is sent through the delay (W) and the sound that is not sent through the delay (D).
OUTPUT LEVEL	0–127	Output Level

69: DISTORTION → CHORUS

The parameters are essentially the same as in "66: OVERDRIVE → CHORUS," with the exception of the following two.

- Overdrive Drive → Distortion Drive,
- Overdrive Pan → Distortion Pan

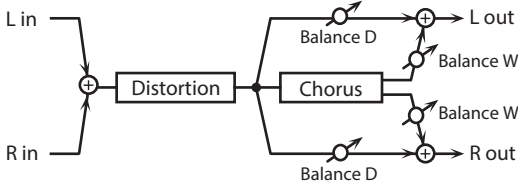

70: DISTORTION → FLANGER

The parameters are essentially the same as in "67: OVERDRIVE → FLANGER," with the exception of the following two.

- Overdrive Drive → Distortion Drive,
- Overdrive Pan → Distortion Pan

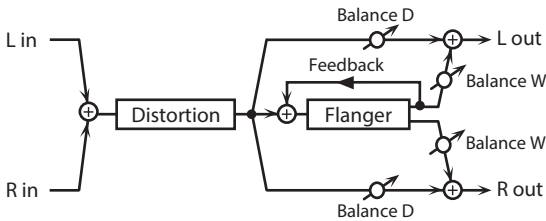

71: DISTORTION → DELAY

The parameters are essentially the same as in "68: OVERDRIVE → DELAY," with the exception of the following two.

- Overdrive Drive → Distortion Drive,
- Overdrive Pan → Distortion Pan

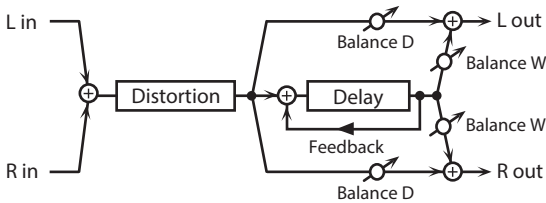

72: ENHANCER → CHORUS

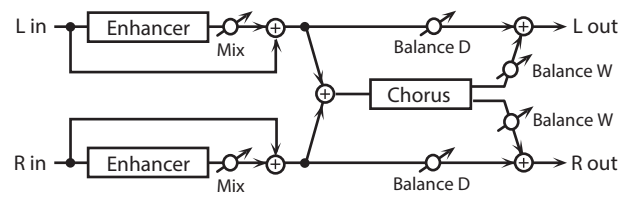

Parameter	Value	Explanation
ENHANCER SENS #	0-127	Sensitivity of the enhancer
ENHANCER MIX #	0-127	Level of the overtones generated by the enhancer
CHORUS RATE #	0.05-10.00 Hz, note	Frequency of modulation
CHORUS DEPTH	0-127	Depth of modulation
CHORUS PRE DELAY	0.0-100 msec	Adjusts the delay time from the direct sound until the chorus sound is heard.
CHORUS BALANCE #	D100:0W-D0:100W	Adjusts the volume balance between the sound that is sent through the chorus (W) and the sound that is not sent through the chorus (D).
OUTPUT LEVEL	0-127	Output Level

73: ENHANCER → FLANGER

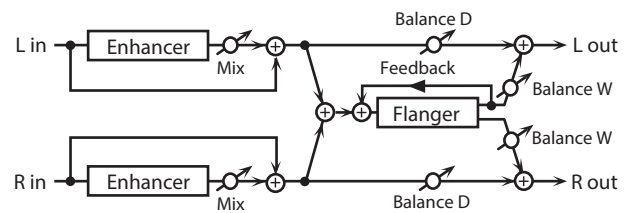

Parameter	Value	Explanation
ENHANCER SENS #	0-127	Sensitivity of the enhancer
ENHANCER MIX #	0-127	Level of the overtones generated by the enhancer
FLANGER RATE #	0.05-10.00 Hz, note	Frequency of modulation
FLANGER DEPTH	0-127	Depth of modulation
FLANGER FEEDBACK #	-98-+98 %	Adjusts the proportion of the flanger sound that is fed back into the effect. Negative (-) settings will invert the phase.
FLANGER PRE DELAY	0.0-100 msec	Adjusts the delay time from when the direct sound begins until the flanger sound is heard.
FLANGER BALANCE #	D100:0W-D0:100W	Adjusts the volume balance between the sound that is sent through the flanger (W) and the sound that is not sent through the flanger (D).
OUTPUT LEVEL	0-127	Output Level

74: ENHANCER → DELAY

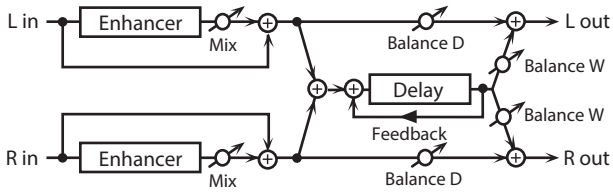

Parameter	Value	Explanation
ENHANCER SENS #	0–127	Sensitivity of the enhancer
ENHANCER MIX #	0–127	Level of the overtones generated by the enhancer
DELAY TIME	0–2600 msec, note	Adjusts the delay time from the direct sound until the delay sound is heard.
DELAY FEEDBACK #	-98–+98 %	Adjusts the proportion of the delay sound that is fed back into the effect. Negative (-) settings will invert the phase.
DELAY HF DAMP	200–8000 Hz, BYPASS	Adjusts the frequency above which sound fed back to the effect will be cut. If you do not want to cut the high frequencies, set this parameter to BYPASS.
DELAY BALANCE #	D100:0W–D0:100W	Adjusts the volume balance between the sound that is sent through the delay (W) and the sound that is not sent through the delay (D).
OUTPUT LEVEL	0–127	Output Level

75: CHORUS → DELAY

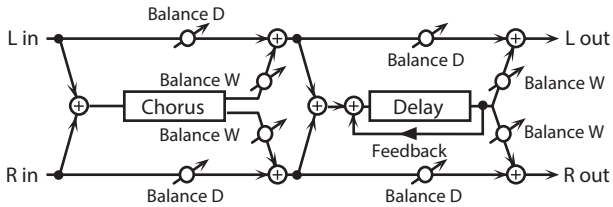

Parameter	Value	Explanation
CHORUS RATE #	0.05–10.00 Hz, note	Frequency of modulation
CHORUS DEPTH	0–127	Depth of modulation
CHORUS PRE DELAY	0.0–100 msec	Adjusts the delay time from the direct sound until the chorus sound is heard.
CHORUS BALANCE #	D100:0W–D0:100W	Volume balance between the direct sound (D) and the chorus sound (W)
DELAY TIME	0–2600 msec, note	Adjusts the delay time from the direct sound until the delay sound is heard.
DELAY FEEDBACK #	-98–+98 %	Adjusts the proportion of the delay sound that is fed back into the effect. Negative (-) settings will invert the phase.
DELAY HF DAMP	200–8000 Hz, BYPASS	Adjusts the frequency above which sound fed back to the effect will be cut. If you do not want to cut the high frequencies, set this parameter to BYPASS.
DELAY BALANCE #	D100:0W–D0:100W	Adjusts the volume balance between the sound that is sent through the delay (W) and the sound that is not sent through the delay (D).
OUTPUT LEVEL	0–127	Output Level

76: FLANGER → DELAY

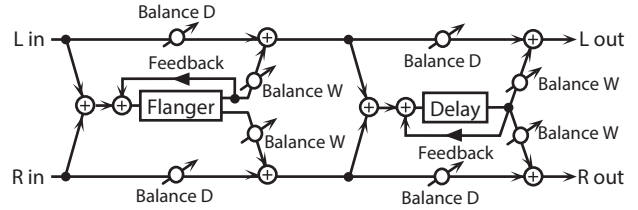

Parameter	Value	Explanation
FLANGER RATE #	0.05–10.00 Hz, note	Frequency of modulation
FLANGER DEPTH	0–127	Depth of modulation
FLANGER FEEDBACK #	-98–+98 %	Adjusts the proportion of the flanger sound that is fed back into the effect. Negative (-) settings will invert the phase.
FLANGER PRE DELAY	0.0–100 msec	Adjusts the delay time from when the direct sound begins until the flanger sound is heard.
FLANGER BALANCE #	D100:0W–D0:100W	Volume balance between the direct sound (D) and the flanger sound (W)
DELAY TIME	0–2600 msec, note	Adjusts the delay time from the direct sound until the delay sound is heard.
DELAY FEEDBACK #	-98–+98 %	Adjusts the proportion of the delay sound that is fed back into the effect. Negative (-) settings will invert the phase.
DELAY HF DAMP	200–8000 Hz, BYPASS	Adjusts the frequency above which sound fed back to the effect will be cut. If you do not want to cut the high frequencies, set this parameter to BYPASS.
DELAY BALANCE #	D100:0W–D0:100W	Adjusts the volume balance between the sound that is sent through the delay (W) and the sound that is not sent through the delay (D).
OUTPUT LEVEL	0–127	Output Level

77: CHORUS → FLANGER

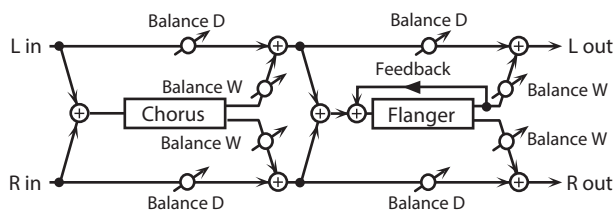

Parameter	Value	Explanation
CHORUS RATE #	0.05–10.00 Hz, note	Modulation frequency of the chorus effect
CHORUS DEPTH	0–127	Modulation depth of the chorus effect
CHORUS PRE DELAY	0.0–100 msec	Adjusts the delay time from the direct sound until the chorus sound is heard.
CHORUS BALANCE #	D100:0W–D0:100W	Volume balance between the direct sound (D) and the chorus sound (W)
FLANGER RATE #	0.05–10.00 Hz, note	Modulation frequency of the flanger effect
FLANGER DEPTH	0–127	Modulation depth of the flanger effect
FLANGER FEEDBACK #	-98–+98 %	Adjusts the proportion of the flanger sound that is fed back into the effect. Negative (-) settings will invert the phase.
FLANGER PRE DELAY	0.0–100 msec	Adjusts the delay time from when the direct sound begins until the flanger sound is heard.
FLANGER BALANCE #	D100:0W–D0:100W	Adjusts the volume balance between the sound that is sent through the flanger (W) and the sound that is not sent through the flanger (D).
OUTPUT LEVEL	0–127	Output Level

78: SYMPATHETIC RESONANCE

On an acoustic piano, holding down the damper pedal allows other strings to resonate in sympathy with the notes you play, creating rich and spacious resonances. This effect simulates these sympathetic resonances.

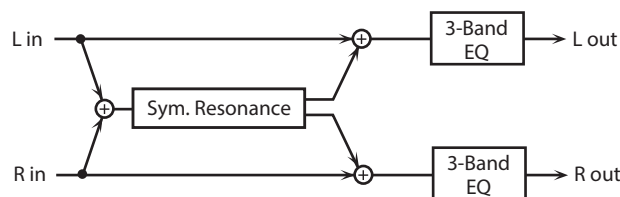

Parameter	Value	Explanation
RESONANCE DEPTH #	0–127	Depth of the effect
RESONANCE DAMPER #	0–127	Depth to which the damper pedal is pressed (controls the resonant sound)
RESONANCE PRE LPF	16–15000 Hz, BYPASS	Frequency of the filter that cuts the high-frequency content of the input sound (BYPASS: no cut)
RESONANCE PRE HPF	BYPASS, 16–15000 Hz	Frequency of the filter that cuts the low-frequency content of the input sound (BYPASS: no cut)
RESONANCE PEAKING FREQ	200–8000 Hz	Frequency of the filter that boosts/cuts a specific frequency region of the input sound
RESONANCE PEAKING Q	0.5, 1.0, 2.0, 4.0, 8.0	Width of the frequency region boosted/cut by the 'Peaking Gain' parameter (larger values make the region narrower)
RESONANCE PEAKING GAIN	-15–+15 dB	Amount of boost/cut produced by the filter at the specified frequency region of the input sound
RESONANCE HF DAMP	16–15000 Hz, BYPASS	Frequency at which the high-frequency content of the resonant sound will be cut (BYPASS: no cut)
RESONANCE LF DAMP	BYPASS, 16–15000 Hz	Frequency at which the low-frequency content of the resonant sound will be cut (BYPASS: no cut)
RESONANCE LID	1–6	This simulates the actual changes in sound that occur when the lid of a grand piano is set at different heights.
LOW FREQ	200, 400 Hz	Frequency of the low-range of the EQ
LOW GAIN	-15–+15 dB	Amount of boost/cut for the low-range of the EQ
MID FREQ	200–8000 Hz	Frequency of the mid-range of the EQ
MID GAIN	-15–+15 dB	Amount of mid-range of the EQ boost/cut
MID Q	0.5, 1.0, 2.0, 4.0, 8.0	Width of mid-range of the EQ (larger values make the region narrower)
HIGH FREQ	2000, 4000, 8000 Hz	Frequency of the high-range of the EQ
HIGH GAIN	-15–+15 dB	Amount of boost/cut for the high-range of the EQ
OUTPUT LEVEL	0–127	Output Level

Chorus Parameters

The SRX WORLD's Chorus effect unit can also be used as a stereo delay unit. These settings allow you to select chorus or delay, and the characteristics of the selected effect type.

Parameter	Value	Explanation
CHORUS		
RATE	0.05–10.00 Hz, note	Modulation frequency of the chorus effect
DEPTH	0–127	Modulation depth of the chorus effect
PRE DELAY	0.0–100 msec	Adjusts the delay time from the direct sound until the chorus sound is heard.
FEEDBACK	0–127	Adjusts the amount of the chorus sound that is fed back into the effect.
FILTER TYPE	OFF, LPF, HPF	Type of filter OFF : no filter is used LPF : cuts the frequency range above the Cutoff Freq HPF : cuts the frequency range below the Cutoff Freq
CUTOFF	200–8000 Hz	Basic frequency of the filter
PHASE	0–180 deg	Spatial spread of the sound
DELAY		
DELAY TIME LEFT		
DELAY TIME CENTER	0–1000 msec, note	Adjusts the delay time from the direct sound until the delay sound is heard.
DELAY TIME RIGHT		
CENTER FEEDBACK	-98–+98 %	Adjusts the proportion of the delay sound that is fed back into the effect. Negative (-) settings will invert the phase.
HF DAMP	200–8000 Hz, BYPASS	Adjusts the frequency above which sound fed back to the effect will be cut. If you do not want to cut the high frequencies, set this parameter to BYPASS.
DELAY LEVEL LEFT		
DELAY LEVEL CENTER	0–127	Volume of each delay sound
DELAY LEVEL RIGHT		
GM2 CHORUS		
LEVEL	0–127	Volume of the chorus sound
FEEDBACK	0–127	Adjusts the amount of the chorus sound that is fed back into the effect.
PRE LPF	0–7	Cuts the high frequency range of the sound coming into the chorus. Higher values will cut more of the high frequencies.
DELAY	0–127	Adjusts the delay time from the direct sound until the chorus sound is heard.
RATE	0–127	Frequency of modulation
DEPTH	0–127	Depth of modulation
SEND LEVEL TO REVERB	0–127	Adjusts the amount of chorus sound that will be sent to the reverb.

Reverb Parameters

These settings allow you to select the desired type of reverb, and its characteristics.

Parameter	Value	Explanation
REVERB		
TYPE	ROOM1 ROOM2 STAGE1 STAGE2 HALL 1 HALL 2 DELAY PAN-DELAY	Type of reverb/delay ROOM1 : short reverb with high density ROOM2 : short reverb with low density STAGE1 : reverb with greater late reverberation STAGE2 : reverb with strong early reflections HALL 1 : very clear-sounding reverb HALL 2 : rich reverb DELAY : conventional delay effect PAN-DELAY : delay effect with echoes that pan left and right
TIME	0–127	Time length of reverberation (Type: ROOM1–HALL2) Delay time (Type: DELAY, PAN-DELAY)
HF DAMP	200–8000 Hz, BYPASS	Adjusts the frequency above which the high-frequency content of the reverb sound will be cut. If you do not want to cut the high frequencies, set this parameter to BYPASS.
FEEDBACK	0–127	Adjusts the amount of delay feedback when the Type setting is DELAY or PAN-DELAY. Amount of delay sound returned to the input (this setting is valid only if Type is DELAY or PAN-DELAY)
SRV ROOM SRV HALL SRV PLATE		
PRE DELAY	0.0–100 msec	Adjusts the delay time from the direct sound until the reverb sound is heard.
TIME	0–127	Time length of reverberation
SIZE	1–8	Size of the simulated room or hall
HIGH CUT	160–12500 Hz, BYPASS	Adjusts the frequency above which the high-frequency content of the reverb will be reduced. If you do not want to reduce the high frequencies, set this parameter to BYPASS.
DENSITY	0–127	Density of reverb
DIFFUSION	0–127	Adjusts the change in the density of the reverb over time. The higher the value, the more the density increases with time. (The effect of this setting is most pronounced with long reverb times.)
LF DAMP	50–4000 Hz	Adjusts the frequency below which the low-frequency content of the reverb sound will be reduced.
LF DAMP GAIN	-36–0 dB	Adjusts the amount of damping applied to the frequency range selected with LF Damp. With a setting of 0, there will be no reduction of the reverb's low-frequency content.
HF DAMP	4000–12500 Hz	Adjusts the frequency above which the high-frequency content of the reverb sound will be reduced.
HF DAMP GAIN	-36–0 dB	Adjusts the amount of damping applied to the frequency range selected with HF Damp. With a setting of 0, there will be no reduction of the reverb's high-frequency content.

Parameter	Value	Explanation
GM2 REVERB		
LEVEL	0-127	Output level of reverberation
CHARACTER	0-7	Type of reverb 0-5: reverb 6, 7: delay
PRE-LPF	0-7	Cuts the high frequency range of the sound coming into the reverb. Higher values will cut more of the high frequencies.
TIME	0-127	Time length of reverberation
DELAY FEEDBACK	0-127	Adjusts the amount of the delay sound that is fed back into the effect when the Character setting is 6 or 7.